

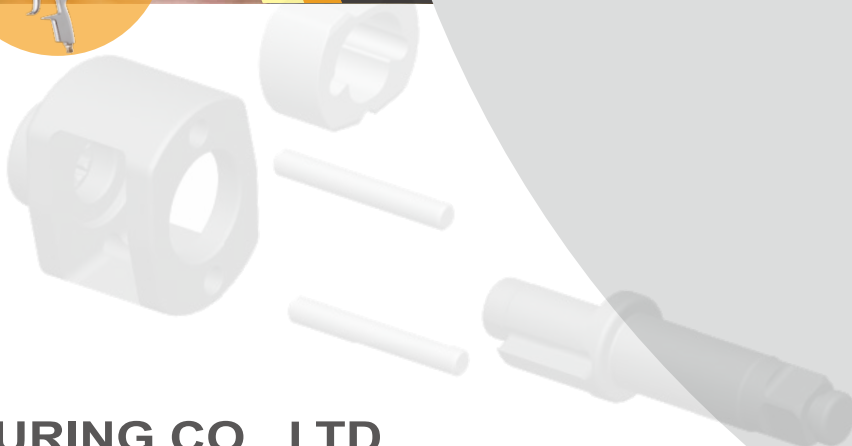

VALUE YOU CAN TRUST



TNT MANUFACTURING CO., LTD.

NO. 483 SEC.1, SANRONG ROAD, WURI TOWNSHIP, TAICHUNG 414, TAIWAN

TEL: 886-4- 23363668 FAX: 886-4-23103706

EMAIL: christine@emaxpowers.com

www.emaxtaiwan.com

www.emaxtools.com

COMPOSITE IMPACT WRENCH - MAGNESIUM ALLOY

LIGHTWEIGHT POWERFUL -TWIN HAMMER

IMPACT MECHANISM

Twin hammer Anvil-
Japan SNCM 616



SPECIAL HARDENING TREATMENT CYLINDER

Cast iron cylinder
Cylinder Material **FCD45**
Heat treatment HRC47~52

AT-5141

1/2"DR IMPACT WRENCH

MAX TORQUE :
800 FT-LB (1080 NM)



AT-1046

3/4"DR IMPACT WRENCH

MAX TORQUE :
1250 FT-LB (1687 NM)



AT-6182P

1"DR PISTOL IMPACT WRENCH

MAX TORQUE :
2000 FT-LB (2700 NM)



AT-6182P-6

1"DR PISTOL IMPACT WRENCH WITH 6" ANVIL

MAX TORQUE :
2000 FT-LB (2700 NM)

Model No.	SQUARE DRIVE	FREE SPEED	MAX TORQUE		OVERALL LENGTH		BOLT CAPACITY	AIR INLET	AIR HOSE	AVG. AIR CONSUMPTION		NET WEIGHT	
		RPM	FT-LB	NM	IN.	MM				CFM	L/MIN	LBS.	KG
AT-5141	1/2"	8500	800	1080	7	179	M19	1/4"	3/8"	5.6	158	3.63	1.65
AT-1035B	3/4"	8500	750	1012	7.8	198	M21	1/4"	3/8"	5.6	158	4.07	1.85
AT-1046	3/4"	6000	1250	1687	8.2	209	M30	3/8"	3/8"	7	198	6.71	3.05
AT-1047	1"	6000	1250	1687	8.2	209	M32	3/8"	3/8"	7	198	6.71	3.05
AT-6182	1"	5500	2000	2700	10.1	256	M40	1/2"	1/2"	7.5	262	12.98	5.9
AT-6182-6	1"	5500	2000	2700	16.4	417	M40	1/2"	1/2"	7.5	262	14.96	6.8

COMPOSITE IMPACT WRENCH - ONE HAND F/R SWITCH

JAMBO / TWIN HAMMER



AT-5144
1/2"DR MINI IMPACT WRENCH
 MAX TORQUE :
 475 FT-LB (645 NM)



One Handed
Operation

AT-5146
1/2"DR IMPACT WRENCH
 MAX TORQUE :
 760 FT-LB (1030 NM)

Model No.	SQUARE DRIVE	FREE SPEED RPM	MAX TORQUE		OVERALL LENGTH		BOLT CAPACITY	AIR INLET	AIR HOSE	AVG. AIR CONSUMPTION		NET WEIGHT	
			FT-LB	NM	IN.	MM				CFM	L/MIN	LBS.	KG
AT-5133	3/8"	10500	430	585	5.9	150	M22	1/4"	3/8"	4.5	127	2.87	1.3
AT-5144	1/2"	9500	475	645	4.4	112	M22	1/4"	3/8"	4.7	133	2.53	1.15
AT-5146	1/2"	7300	760	1030	6.9	175	M27	1/4"	3/8"	5	142	4.37	1.98
AT-5161	3/4"	5300	1330	1800	7.9	200	M30	3/8"	3/8"	7.8	221	7.5	3.4

COMPOSITE IMPACT WRENCH - PUSH BUTTON F/R

TWIN HAMMER



AT-5146TB
1/2"DR IMPACT WRENCH
 MAX TORQUE :
 830 FT-LB (1130 NM)



Model No.	SQUARE DRIVE	FREE SPEED RPM	MAX TORQUE		OVERALL LENGTH		BOLT CAPACITY	AIR INLET	AIR HOSE	AVG. AIR CONSUMPTION		NET WEIGHT	
			FT-LB	NM	IN.	MM				CFM	L/MIN	LBS.	KG
AT-5144JB	1/2"	9500	500	678	4.6	116	M22	1/4"	3/8"	4.8	136	2.6	1.2
AT-5144TB	1/2"	9000	480	651	4.7	120	M22	1/4"	3/8"	4.8	136	2.6	1.2
AT-5146TB	1/2"	7500	830	1130	7.1	180	M27	1/4"	3/8"	4.8	136	4.4	2

SOCKET ADAPTER



Model No.	FEMALE SQUARE DRIVE	MALE SCREW SIZE	PACKING
SA-6001	1/2"	5/8" -11 UNC	100PCS/7KG/9KG/1'
SA-6002	1/2"	3/8" -24 UNF	100PCS/7KG/9KG/1'
SA-6003	1/2"	M14 -2.0	100PCS/7KG/9KG/1'
SA-6004	1/2"	M10-1.5	100PCS/7KG/9KG/1'
SA-6005	5/8" - 11UNC	1/4" - 20UNC	100PCS/7KG/9KG/1'
SA-6006	M14 -2.0	1/4"- 20 UNC	100PCS/7KG/9KG/1'
SA-6007	M10-1.5	1/4"- 20 UNC	100PCS/7KG/9KG/1'



LIGHT DUTY - CHISEL SCALER



AT-2129F

Chisel shank :

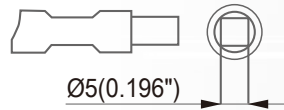

AT-2129FK

CHISEL SCALER X 1PC
AIR NIPPLE (1/4") X 1PC
CHISEL X 3PCS

Model No.	BLOW PER MINUTE	PISTON DIAMETER	PISTON STROKE	AIR INLET	AIR HOSE	AVG. AIR CONSUMPTION		NET WEIGHT		OVERALL LENGTH
	BPM					CFM	L/MIN	LBS.	KG	MM
AT-2129F	10000	10 X 29.8 MM	16MM	1/4"	3/8"	3	84	0.66	0.3	222

CHISEL FOR AIR HAMMER



AT-2050R

9PCS CHISEL SET

SHANK: Ø10.18mm ROUND

JAW OPEN CHISEL : 17MM

FLAT CHISEL

POINT CHISEL

3/8" DRIVE CHISEL

1/2" DRIVE CHISEL

CURVE CHISEL 25MM

FLAT CHISEL 25MM

HALF MOON CHISEL 40 X 68MM

HEAVY DUTY RATCHET WRENCH - LOW NOISE TYPE

ERGONOMIC DESIGN



AT-2403B
3/8"DR RATCHET
HEAD-SEALED DESIGN



AT-3027B
3/8"DR RATCHET
SINGLE PAWL



AT-2402B
1/2"DR RATCHET
TWIN PAWL



SEALED TYPE
PREVENT
HEAD OPEN

Model No.	SQUARE DRIVE	FREE SPEED	MAX TORQUE		OVERALL LENGTH		BOLT CAPACITY	AIR INLET	AIR HOSE	AVG. AIR CONSUMPTION		NET WEIGHT	
		RPM	FT-LB	NM	IN.	MM				CFM	L/MIN	LBS.	KG
AT-2403B	3/8"	300	40	54	5.3	135	M10	1/4"	3/8"	3.7	104	1.1	0.5
AT-3027B	3/8"	300	30	41	7.0	180	M9	1/4"	3/8"	2.6	74	1.58	0.72
AT-2402B	1/2"	180	75	101	9.4	240	M10	1/4"	3/8"	3.9	110	2.70	1.2

PALM SANDER



AT-7582A
PALM SANDER
DISC : 2" OR 3"
ORBIT DIA : 3MM



AT-7249A
3 IN 1 ANGLE SANDER
ANGLE SANDER/CUT-OFF/GRINDER
w/o Cutting wheel & Grinding wheel

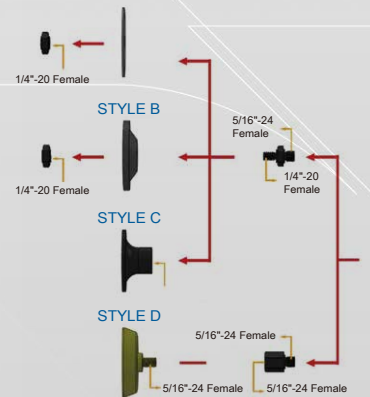

Model No.	DISC SIZE	FREE SPEED	ORBIT DIA	SPINDLE	OVERALL LENGTH		AIR INLET	AIR HOSE	AVG. AIR CONSUMPTION		NET WEIGHT	
		RPM	MM		IN.	MM			CFM	L/MIN	LBS.	KG
AT-7582A	2" OR 3"	16000	3	5/16"- 24 UNF	4.8	123	1/4"	3/8"	3	84	1.83	0.83
AT-7582P	2" OR 3"	2600	-	5/16"- 24 UNF	4.8	121	1/4"	3/8"	3	84	1.74	0.79
AT-7249A	2"	20000	-	1/4"- 20 UNC	4.8	124	1/4"	3/8"	3	84	1.85	0.84



ANGLE DIE GRINDER

AT-5216AL-10 9,000RPM
AT-5216AL-30 30,000RPM



ANGLE POLISHER

AT-5216AL-DS2 9,000RPM



ANGLE CUTTER

AT-5216AL-T3 9,000RPM



ANGLE SANDER

AT-5216AL-OS1 1"PAD
AT-5216AL-OS14 1.5"PAD
AT-5216AL-OS2 2"PAD

Model No.	FREE SPEED	ORBIT DIA. (MM)	OVERALL	AIR INLET	AIR HOSE	AVG. AIR CONSUMPTION		NET WEIGHT	
	RPM		L X H (MM)			CFM	L/MIN	LBS.	KG
AT-5216AL-10	9000	-	120 x 83	1/4"	3/8"	2.3	65	0.88	0.4
AT-5216AL-30	30000	-	120 x 83	1/4"	3/8"	2.3	65	0.88	0.4
AT-5216AL-DS2	9000	-	120 x 66	1/4"	3/8"	2.3	65	0.92	0.42
AT-5216AL-T3	9000	-	120 x 94	1/4"	3/8"	2.3	65	1.14	0.52
AT-5216AL-OS1	9000	2.5	120 x 97	1/4"	3/8"	2.3	65	1.06	0.48
AT-5216AL-OS14	9000	2.5	120 x 97	1/4"	3/8"	2.3	65	1.06	0.48
AT-5216AL-OS2	9000	2.5	120 x 97	1/4"	3/8"	2.3	65	1.06	0.48

INDUSTRIAL MINI TOOLS



MINI BELT SANDER

AT-5216-BS1033A BELT SIZE:10X330mm
 AT-5216-BS1333A BELT SIZE:13X330mm
 AT-5216-BS1345A BELT SIZE:13X457mm



ANGLE SANDER

AT-5216AL-OS3 3"PAD
 FREE SPEED : 9000RPM

Model No.	FREE SPEED	ORBIT DIA. (MM)	OVERALL	AIR INLET	AIR HOSE	AVG. AIR CONSUMPTION		NET WEIGHT	
	RPM		L X H (MM)			CFM	L/MIN	LBS.	KG
AT-5216-BS1033A	9000	-	247	1/4"	3/8"	2.3	65	1.32	0.6
AT-5216-BS1333A	9000	-	247	1/4"	3/8"	2.3	65	1.32	0.6
AT-5216-BS1345A	9000	-	310	1/4"	3/8"	2.3	65	1.32	0.6
AT-5216AL-OS3	9000	3	120 x 74	1/4"	3/8"	2.3	65	1.10	0.5

CHAMFER TOOL

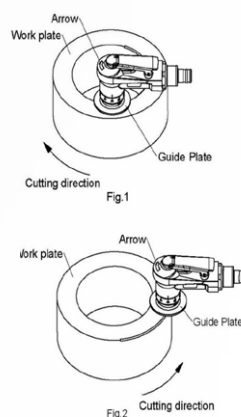

AT-5216AL WITHOUT HOSE

AT-5216 WITH HOSE

Model No.	FREE SPEED	OVERALL	AIR INLET	AIR HOSE	AVG. AIR CONSUMPTION		NET WEIGHT	
	RPM				L X H (MM)	CFM	L/MIN	LBS.
AT-5216AL	30000	120 x 65	1/4"	3/8"	2.3	65.09	1.07	0.48
AT-5216	28000	120 x 65 + 148	1/4"	3/8"	2.3	65.09	1.1	0.5

DRILL



AT-4030E

3/8"DR DRILL
RUBBER HANDLE
FREE SPEED: 2,200 RPM



F/R



AT-3038K

3/8"DR REVERSIBLE DRILL
RUBBER HANDLE
W/ KEYLESS CHUCK
FREE SPEED: 1,800 RPM



AT-3038KB

3/8"DR REVERSIBLE DRILL
13MM KEYLESS CHUCK
FREE SPEED: 1,800 RPM



AT-4500

1/2"DR REVERSIBLE DRILL
RUBBER HANDLE
FREE SPEED: 500 RPM



AT-4040E

1/2"DR DRILL

AT-4012

1/2"DR REVERSIBLE DRILL
RUBBER HANDLE
FREE SPEED: 800 RPM



AT-4012RK

1/2"DR REVERSIBLE
KEYLESS DRILL
RUBBER HANDLE
FREE SPEED: 800 RPM

Model No.	SQUARE DRIVE	FREE SPEED RPM	OVERALL LENGTH		AIR INLET (PT)	AIR HOSE (ID)	AVG. AIR CONSUMPTION		NET WEIGHT	
			RPM	IN.			CFM	L/MIN	LBS.	KG
AT-4030E	3/8"	2,200	7 2/7"	185	1/4"	3/8"	4.0	113	2.4	1.1
AT-3038	3/8"	1,800	7 2/7"	185	1/4"	3/8"	4.0	113	2.4	1.1
AT-3038K	3/8"	1,800	7 2/7"	185	1/4"	3/8"	4.0	113	2.4	1.1
AT-3038KB	3/8"	1,800	7 2/7"	185	1/4"	3/8"	4.0	113	2.4	1.1
AT-4500	1/2"	500	9"	230	1/4"	3/8"	4.0	113	2.9	1.3
AT-4040E	1/2"	800	8 1/4"	210	1/4"	3/8"	4.0	113	2.4	1.1
AT-4012	1/2"	800	8 1/4"	210	1/4"	3/8"	4.0	113	2.4	1.1
AT-4012RK	1/2"	800	8 1/4"	210	1/4"	3/8"	4.0	113	2.4	1.1

METAL SHEAR



AT-6022

PISTOL METAL SHEAR
FREE SPEED: 2,200 RPM

SCREWDRIVER



AT-4008

ADJUSTABLE CLUTCH SCREWDRIVER
FREE SPEED: 800 RPM

AT-4018

ADJUSTABLE CLUTCH SCREWDRIVER
FREE SPEED: 1,800 RPM

Model No.	FREE SPEED (RPM)	WIDE OF CUT MM	OVERALL LENGTH		AIR INLET (PT)	AIR HOSE (ID)	AVG. AIR CONSUMPTION		NET WEIGHT	
			IN.	MM			CFM	L/MIN	LBS.	KG
AT-6022	2,200	5.5	9"	215	1/4"	3/8"	6	170	2.2	1

Model No.	HEX SHANK SIZE	FREE SPEED RPM	TORQUE		AIR INLET (PT)	AIR HOSE (ID)	AVG. AIR CONSUMPTION		NET WEIGHT	
			IN-LBS	N-M			CFM	L/MIN	LBS.	KG
AT-4008	1/4" (6.35MM)	800	45-145	5-16.4	1/4"	3/8"	4	113	2.6	1.2
AT-4018	1/4" (6.35MM)	1800	20-115	2.3-13	1/4"	3/8"	4	113	2.6	1.2

DIE GRINDER



AT-7033D(M)
1/4" (6MM) DIE GRINDER
FREE SPEED: 22,000 RPM



AT-7033E(M)
1/4" (6MM) DIE GRINDER
LOW SPEED TYPE
FREE SPEED: 4,000 RPM



AT-7033DL(M)
1/4" (6MM) EXTENDED
DIE GRINDER
FREE SPEED: 22,000 RPM



AT-7034D(M)
1/4" (6MM) ANGLE DIE GRINDER
FREE SPEED: 18,000 RPM



GS-10 1/4" (6MM)
10PCS GRINDER STONES SET



Model No.	FREE SPEED (RPM)	COLLET SIZE	OVERALL LENGTH		AIR INLET (PT)	AIR HOSE (ID)	AVG. AIR CONSUMPTION		NET WEIGHT	
			IN.	MM			CFM	L/MIN	LBS.	KG
AT-7033D(M)	22,000	1/4" (6MM)	6 3/4"	170	1/4"	3/8"	4	113	1.5	0.7
AT-7033E(M)	4,000	1/4" (6MM)	8 1/4"	210	1/4"	3/8"	4	113	2.2	1
AT-7033DL(M)	22,000	1/4" (6MM)	10 1/4"	260	1/4"	3/8"	4	113	1.5	0.7
AT-7034D(M)	18,000	1/4" (6MM)	6 3/4"	170	1/4"	3/8"	4	113	1.8	0.8

STRAIGHT TYPE AUTO REPAIR TOOLS



AT-3038S
3/8" STRAIGHT DRILL
RUBBER GRIP
FREE SPEED: 2,500 RPM



AT-6020A
AIR METAL SHEAR
FREE SPEED: 2,500 RPM



AT-6014D
KNIFE
FREE SPEED: 20,000 RPM



KF-003-1A **KF-003-1B**



KF-003-3A **KF-003-2C** **KF-003-2C**

Model No.	SQUARE DRIVE	FREE SPEED RPM	OVERALL LENGTH		AIR INLET (PT)	AIR HOSE (ID)	AVG. AIR CONSUMPTION		NET WEIGHT	
			IN.	MM			CFM	L/MIN	LBS.	KG
AT-3038S	3/8"	2,500	8 4/9"	215	1/4"	3/8"	4.0	113	2.2	1.1

Model No.	FREE SPEED (RPM)	WIDE OF CUT MM /IN.	OVERALL LENGTH		AIR INLET (PT)	AIR HOSE (ID)	AVG. AIR CONSUMPTION		NET WEIGHT	
			IN.	MM			CFM	L/MIN	LBS.	KG
AT-6020A	2,500	5.5 (7/32")	9 6/7"	250	1/4"	3/8"	4	113	2.6	1.2
AT-6014D	20,000	3	7 5/7"	195	1/4"	3/8"	4	113	2.2	1

STRAIGHT TYPE AUTO REPAIR TOOLS



AT-6030MA

CUT OFF TOOL

FREE SPEED: 20,000 RPM



AT-6056E

H.D. TIRE BUFFER

FREE SPEED: 2,500 RPM



AT-6034E

SMART ERASER

FREE SPEED: 2,500 RPM



P6034-34



P6034-34D



P6034-40 SHAFT

Model No.	FREE SPEED (RPM)	COLLET SIZE	OVERALL LENGTH		AIR INLET (PT)	AIR HOSE (ID)	AVG. AIR CONSUMPTION		NET WEIGHT	
			IN.	MM			CFM	L/MIN	LBS.	KG
AT-6030MA	20,000	3" (76.2mm)	7	180	1/4"	3/8"	4	113	1.8	0.8

Model No.	FREE SPEED (RPM)	SANDING / CHUCK SIZE	OVERALL LENGTH		AIR INLET (PT)	AIR HOSE (ID)	AVG. AIR CONSUMPTION		NET WEIGHT	
			IN.	MM			CFM	L/MIN	LBS.	KG
AT-6034E	2,500	7/16" (11MM)	8 7/8"	225	1/4"	3/8"	4	113	2.2	1
AT-6056E	2,500	7/16" (11MM)	8 1/3"	210	1/4"	3/8"	4	113	2.2	1

RATCHET WRENCH



AT-3138

3/8"DR RATCHET WRENCH

MAX TORQUE: 50FT-LB (68NM)

AT-4138

1/2"DR RATCHET WRENCH

MAX TORQUE: 50FT-LB (68NM)

Model No.	SQUARE DRIVE	FREE SPEED RPM	MAX TORQUE		AIR INLET (PT)	AIR HOSE (ID)	AVG. AIR CONSUMPTION		OVERALL LENGTH MM	NET WEIGHT	
			FT-LB	NM			CFM	L/MIN		LBS.	KG
AT-3138	3/8"	160	50	68	1/4"	3/8"	4	113	265	2.9	1.32
AT-4138	1/2"	160	50	68	1/4"	3/8"	4	113	265	2.9	1.32

BELT SANDER / CUT OFF TOOL



AT-7006B

BELT SANDER 6X330MM (#80 #100 #120)

AT-7009ABS

BELT SANDER 10X330MM (#80 #100 #120)

AT-7009C

BELT SANDER 10X457MM (#80 #100)

AT-7012B

BELT SANDER 12X610MM (#80 #100)



AT-7020B

BELT SANDER 20X520MM

(#80 #100)



AT-6028

3" CUT OFF TOOL

FREE SPEED: 15,000 RPM

Model No.	SANDING BELT		FREE SPEED RPM	OVERALL LENGTH		AIR INLET (PT)	AIR HOSE (ID)	AVG. AIR CONSUMPTION		NET WEIGHT	
	IN.	MM		IN.	MM			CFM	L/MIN	LBS.	KG
AT-7006B	1/4" X 13"	6 X 330	16,000	12 1/2"	320	1/4"	3/8"	4	113	2.1	0.95
AT-7009ABS	2/5" X 13"	10 X 330	16,000	12 1/2"	320	1/4"	3/8"	4	113	2.1	0.95
AT-7009C	2/5" X 18"	10 X 457	16,000	15 1/4"	385	1/4"	3/8"	4	113	2.1	1.1
AT-7012B	1/2" X 24"	12 X 610	16,000	17 15/16"	455	1/4"	3/8"	4	113	2.4	1.2
AT-7020B	7/8" X 20"	20 X 520	16,000	16 15/16"	430	1/4"	3/8"	4	113	3.1	1.4
Model No.	Cutting Wheel		RPM	OVERALL LENGTH		INLET	HOSE	CFM	L/MIN	LBS.	KG
AT-6028	3" / 76.2mm		15,000	13 4/5"	350	1/4"	3/8"	4	113	3	1.38



AT-5140K1

7PCS 1/2"DR.

COMPOSITE IMPACT WRENCH KIT

- 1PC AT-5140 1/2"DR. IMPACT WRENCH
- 1PC DEEP SOCKET 15MM CR-MO
- 1PC DEEP SOCKET 17MM CR-MO
- 1PC DEEP SOCKET 19MM CR-MO
- 1PC DEEP SOCKET 21MM CR-MO
- 1PC OIL POT
- 1PC CONNECTOR



AT-5140K2 (CR-MO) 16PCS 1/2"DR. COMPOSITE IMPACT WRENCH KIT

AT-5140K3 (CR-V)

1PC 1/2"DR. COMPOSITE IMPACT WRENCH

- SOCKETS: 9, 10, 11, 13, 14, 17, 19, 22, 24, 27MM
- 1PC 5" EXTENSION BAR
- 1PC OIL POT
- 1PC MINI OILER
- 1PC CONNECTOR
- 1PC BLOW MOULD CASE

AT-5140K5

17PCS 1/2"DR. IMPACT WRENCH (CR-MO)

- 1PC 1/2"DR. COMPOSITE IMPACT WRENCH
- SOCKETS: 9, 10, 11, 13, 14, 17, 19, 22, 24, 27MM
- 1PC 5" EXTENSION BAR
- 1PC OIL POT
- 1PC MINI OILER
- 1PC CONNECTOR
- 1PC 1/4" AIR INLET



AT-7033D(M)K

1/4" (6MM) DIE GRINDER KIT

- 1PC AT-7033D(M) DIE GRINDER
- 1PC SPANNERS
- 5PCS 1/4" SHANK GRINDING STONES
- 5PCS 1/8" SHANK GRINDING STONES
- 1PC 1/8" COLLET
- 1PC NIPPLE
- 1PC BLOW MOULD CASE
- NET WEIGHT:1.2KG



AT-7034D(M)K

1/4"(6MM)ANGLE DIE GRINDER KIT

- 1PC AT-7034D(M) DIE GRINDER
- 1PC SPANNERS
- 5PCS 1/4" SHANK GRINDING STONES
- 5PCS 1/8" SHANK GRINDING STONES
- 1PC 1/8" COLLET
- 1PC NIPPLE
- 1PC BLOW MOULD CASE
- NET WEIGHT:1.3KG



AT-6014AK

KNIFE KIT

- 1PC 5MM WRENCH KEY
- 1PC 57MM BLADE
- 1PC 30MM BLADE
- 1PC 35MM BLADE
- 1PC BLOW CASE



AT-6111K

BODY SAW KIT

- 5PCS 32T SAW BLADES
- 5PCS 24T SAW BLADES
- 2PCS HEX. WRENCH (3MM & 4MM)
- 1PC MINI OILER
- 1PC SWIVEL CONNECTOR
- 5PCS FILES
- 1PC BLOW MOULD CASE

PNEUMATIC HIGH FLOW OIL & LIQUID DISPENSER

MODEL NO. : AA-2111A

- AIR INLET: 1/4"
- AVG. AIR CONS: 2.5 CFM
- WORKING PRESSURE: 30-90 PSI

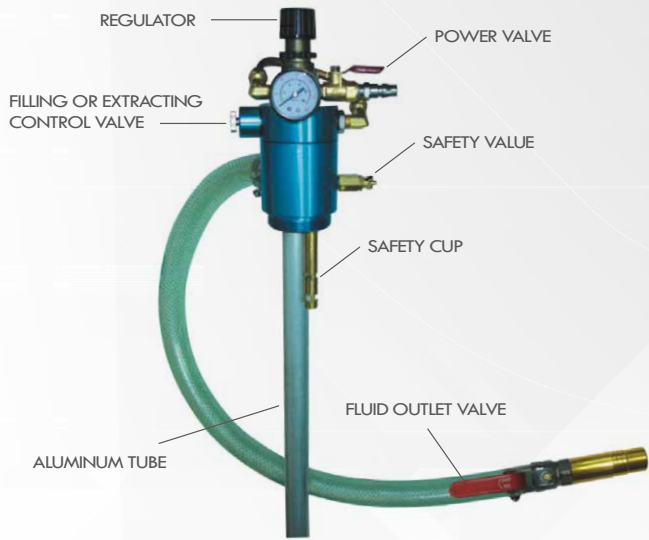

EXTRACTING
FILLING OIL & LIQUID
ONLY NEED 6 MINUTES!



PNEUMATIC PISTON OIL & LIQUID PUMP

MODEL NO. : AA-2111N

- AIR INLET: 1/4"
- AVG. AIR CONS: 2.5 CFM
- WORKING PRESSURE: 30-90 PSI
- 2m HOSE: 1/2" ID
- FLOW: 7~11 l/min

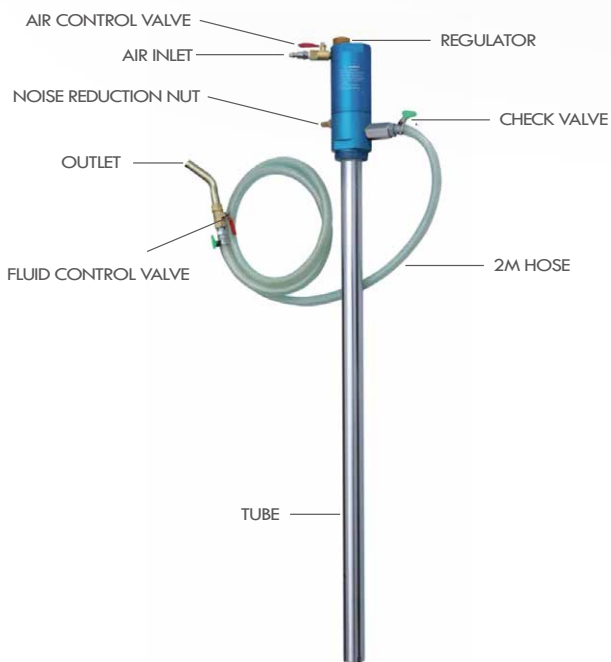

FILLING OIL & LIQUID
NEED 25 MINUTES!



FOR 50 GAL./ INDUSTRY / DIESEL / WATER FLUID

EMAX



TNT MANUFACTURING CO., LTD

EMAX



TNT MANUFACTURING CO., LTD

NO.483, SEC.1, SANRONG RD., WURI DIST.,
TAICHUNG CITY, 414, TAIWAN, R.O.C.
Tel: 886-4-2336-3668 Fax: 886-4-2310-3706

www.emaxtaiwan.com



2014.2000

PROFESSIONAL PNEUMATIC TOOL

TUV CE ISO 9001-2000

AT-7320
2" Random Orbital Sander

AT-7330
3" Random Orbital Sander

AT-7330P
3" Polish

- COMPOSITE

AT-6712
Super Duty Mini Sander

AT-6628
3" Heavy Duty Mini Orbital Sander

AT-6552
3" Super Duty Polish

- COMPOSITE

AT-7112
3" Mini Disc Sander

AT-7111
2" Mini Random Orbital Sander

AT-7119
Mini Sander

AT-7117
2" Mini Sander

AT-7006B
Belt Sander - 6 x 330 mm (#80/100/120)

AT-7009ABS
Belt Sander - 10 x 330 mm (#80/100/120)

AT-7012B
Belt Sander - 12 x 610 mm (#80/100)

AT-7020B
Belt Sander - 20 x 520 mm (#80/100)

- RUBBER HANDLE

AT-7103
Belt Sander (Non. Vac. / Central Vac.)

AT-7073
7" Angle Sander

AT-7073P
7" Angle Polisher

AT-7074S
7" Angle Sander

AT-7074
7" Angle Polisher

AT-7018
Jitterbug Sander

AT-7019
Straight Line Sander

AT-7170
6" Angle Polisher

AT-7180
7" Angle Polisher

AT-7070S
7" Vertical Sander

AT-7070
7" Vertical Polisher

Model No.	Sanding Pad		Free Speed RPM	Overall Length		Air Inlet (PT)	Air Hose (ID)	Avg-Air Consumption		Net Weight		Packing Pcs/Ctn/G.W./Cuft (kgs)
	in.	mm		in.	mm			cfm	l/min	lbs	kgs.	
AT-7320	2"	50	15,000	4 15/16"	125	1/4"	3/8"	3.5	99	1.6	0.72	10/Ctn/9.0/1.0'
AT-7330	3"	74	15,000	4 15/16"	125	1/4"	3/8"	3.5	99	1.6	0.72	10/Ctn/9.0/1.0'
AT-7330P	3"	74	2,100	5 1/3"	135	1/4"	3/8"	3.5	99	1.7	0.77	10/Ctn/9.0/1.0'
AT-7112	3"	74	18,000	7 3/8"	187	1/4"	1/4"	7.0	200	1.3	0.6	10/Ctn/9.0/0.83'
AT-7111	2"	50	18,000	6 7/8"	176	1/4"	1/4"	7.0	200	1.4	0.65	10/Ctn/9.5/0.83'
AT-7117	2"	50	18,000	5 1/8"	130	1/4"	1/4"	2.0	56.6	1.3	0.6	20/Ctn/21.0/0.73'
AT-7119	2"	50	18,000	5 15/16"	150	1/4"	1/4"	2.0	56.6	1.2	0.55	20/Ctn/21.0/0.73'
AT-6712	2" or 3"	50 or 76.2	15,000	5 1/4"	133	1/4"	3/8"	2.1	59.5	1.0	0.45	12/Ctn/11.5/1.24'
AT-6628	3"	76.2	15,000	5 7/8"	145	1/4"	3/8"	2.1	59.5	1.1	0.5	12/Ctn/10.0/1.24'
AT-6552	3"	76.2	6,000	6"	152	1/4"	3/8"	2.1	59.5	1.34	0.61	20/Ctn/15.2/1.2'
AT-7006B	1/4" x 13"	6 x 330	16,000	12 1/2"	320	1/4"	3/8"	4.0	115	2.1	0.95	10/Ctn/11.0/1.4'
AT-7009ABS	2/5" x 13"	10 x 330	16,000	12 1/2"	320	1/4"	3/8"	4.0	115	2.1	0.95	10/Ctn/11.0/1.4'
AT-7012B	1/2" x 24"	12.7 x 610	16,000	17 15/16"	455	1/4"	3/8"	4.0	115	2.4	1.1	10/Ctn/11.0/1.4'
AT-7020B	7/8" x 20"	20 x 520	16,000	16 15/16"	430	1/4"	3/8"	4.0	115	3.1	1.4	10/Ctn/11.0/1.4'

Model No.	Sanding Pad		Spindle Thread	Free Speed RPM	Overall Length		Air Inlet (PT)	Air Hose (ID)	Avg-Air Consumption		Net Weight		Packing Pcs/Ctn/G.W./Cuft (kgs)
	in.	mm			in.	mm			cfm	l/min	lbs	kgs.	
AT-7103	23/8" x 10"	60 x 260	-	7,000	7"	178	1/4"	1/4"	8.8	250	2.4	1.1	12/Ctn/23.0/2.6'
AT-7018	3 2/3" x 3/4"	93 x 19	-	8,000	7 5/16"	185	1/4"	3/8"	3.5	99	4.2	1.9	10/Ctn/21.5/1.4'
AT-7019	2 1/2" x 1 1/2"	64 x 407	-	2,500	16"	410	1/4"	3/8"	6	170	6.6	3.0	10/Ctn/23.0/1.44'
AT-7073	7"	180	5/8" - 11 UNC	4,500	13"	330	1/4"	3/8"	8.0	227	4.8	2.2	6/Ctn/17.0/1.75'
AT-7073P	7"	180	5/8" - 11 UNC	2,800	13"	330	1/4"	3/8"	8.0	227	4.8	2.2	6/Ctn/17.0/1.75'
AT-7074S	7"	180	5/8" - 11 UNC	4,500	15 3/4"	400	1/4"	3/8"	8.0	227	5.4	2.45	6/Ctn/17.0/1.75'
AT-7074	7"	180	5/8" - 11 UNC	2,200	15 3/4"	400	1/4"	3/8"	8.0	227	5.4	2.45	6/Ctn/17.0/1.75'
AT-7170	7"	152	5/8" - 11 UNC	2,500	7 5/16"	185	1/4"	3/8"	3.0	84.9	3.5	1.6	10/Ctn/16/1.4'
AT-7180	7"	152	5/8" - 11 UNC	3,200	7 5/16"	185	1/4"	3/8"	3.0	84.9	3.5	1.6	10/Ctn/16/1.4'
AT-7070S	7"	180	5/8" - 11 UNC	4,000	7 5/16"	185	1/4"	3/8"	6	170	4.0	1.8	6/Ctn/16.5/1.0'
AT-7070	7"	180	5/8" - 11 UNC	2,000	7 5/16"	185	1/4"	3/8"	6	170	4.0	1.8	6/Ctn/16.5/1.0'

CHIPPER

HAMMER



AT-2507
Flux Chipper



AT-2130B
Gasket Scraper



AT-2501
Flux Chipper



AT-2502
Flux Chipper



AT-2168F
Flux Chipper



AT-2368F
Heavy Duty Flux Chipper



AT-2361R/H
190mm Hammer W/ 4pcs Chisels

AT-2362R/H
250mm Hammer W/ 4pcs Chisels



AT-4021R/H
190mm Hammer

AT-4022R/H
250mm Hammer



AT-2320R/H
Short Hammer w/4 chisels & spring



**VIBRATION
REDUCE 30%**

PI-3190HR/H
190mm Hammer

- COMPOSITE BODY

PI-3250HR/H
250mm Hammer



AT-2010R/H
150mm Hammer w/4pcs chises



AT-2620R/H
Short Hammer w/4 chisels & spring

Model No.	Air Inlet (PT)	Avg-Air Consumption		Blow Per Min (BPM)	Sound Pressure level (dba)	Power Pressure level (dba)	Vibration level (M/sec ²)	Overall Length		Net Weight		Packing Pcs/Ctn/G.W./Cuft (kgs)
		cfm	l/min					in.	mm	lbs	kgs.	
AT-2507	1/4"	10	283	5000	90.3	101.7	14.5	16.5"	420	3.96	1.8	10/18/19/0.5'
AT-2130B	1/4"	4	113	4000	91	102	11.4	9.65"	245	1.76	0.8	10/18/19/0.5'
AT-2501	1/4"	10	283	2700	97	107.8	8.7	13.2"	335	4.8	2.2	10/23.5/24/0.5'
AT-2502	1/4"	10	283	2700	97	107.8	8.7	11.6"	295	4.8	2.2	10/24.5/25/0.8'
AT-2168F	1/4"	15	425	4800	97.97	108.97	7.53	14.8"	375	5.3	2.4	6/16/17/1.3'
AT-2368F	1/4"	15	425	4800	98.96	109.95	4.04	17.3"	440	5.3	2.5	6/17/18/1.3'

Model No.	Chisel Shank		Bore Diameter(ID)		Piston Stroke Length		Blow Per Min (BPM)	Overall Length		Air Inlet (PT)	Air Hose (ID)	Avg-Air Cons.		Net Weight		Packing Pcs/Ctn/G.W./Cuft (kgs)
	Round	Hex	in.	mm	in.	mm		in.	mm			CFM	l/min	lbs	kgs.	
AT-2361R/H	0.401"	10	3/4"	19	2 5/16"	58	3,000	8 1/8"	206	1/4"	3/8"	3.0	85	4.2	1.9	10/Ctn/20.0/1.2'
AT-2362R/H	0.401"	10	3/4"	19	3"	76	2,100	9 1/4"	235	1/4"	3/8"	3.0	85	5.1	2.3	10/Ctn/24.0/1.4'
PI-3190R/H	0.401"	10/11	3/4"	19	2 4/5"	71	3,000	8 1/2"	215	1/4"	3/8"	14	397	3.5	1.6	10/Ctn/19.0/1.6'
PI-3250R/H	0.401"	10/11	3/4"	19	3 5/8"	92	2,100	10"	260	1/4"	3/8"	16	453	4.2	1.9	10/Ctn/23.0/1.6'
AT-4021R/H	0.401"	10/11	3/4"	19	2 5/8"	66	3,200	7 1/16"	180	1/4"	3/8"	7.4	210	3.5	1.6	10/Ctn/25.5/1.0'
AT-4022R/H	0.401"	10/11	3/4"	19	3 5/8"	92	2,000	9"	230	1/4"	3/8"	7.1	200	4.4	2.0	10/Ctn/29.0/1.0'
AT-2010R/H	0.401"	10	3/4"	19	1 5/8"	41	4,500	5 1/4"	133	1/4"	3/8"	5.0	143	3.3	1.5	10/Ctn/13.0/0.7'
AT-2320R/H	0.401"	10	3/4"	19	1 3/4"	43	4,300	5 1/3"	135	1/4"	3/8"	6.3	178	2.5	1.1	10/Ctn/16.0/0.8'
AT-2620R/H	0.401"	10	3/4"	19	1 3/4"	43	4,300	5 1/3"	135	1/4"	3/8"	6.3	178	2.7	1.2	10/Ctn/16.0/0.8'



AT-2226R/H
Long Hammer w/ 4 chisels & spring (Round or Hex)



AT-2051R/H
190mm Hammer (Round or Hex)



AT-2061R/H
Hammer (Round or Hex)



AT-2057R/H
250mm Hammer (Round or Hex)



AT-2062R/H
Long Hammer (Round or Hex)



AT-2190R/H
190mm Hammer w/4 Chisels (Round or Hex)

Model No.	Chisel Shank		Bore Diameter(ID)		Piston Stroke Length		Blow Per Min (BPM)	Overall Length		Air Inlet (PT)	Air Hose (ID)	Avg-Air Cons.		Net Weight		Packing Pcs/Ctn/G.W./Cuft (kgs)
	Round	Hex	in.	mm	in.	mm		in.	mm			CFM	l/min	lbs	kgs.	
AT-2226R/H	0.401"	10	3/4"	19	5 7/8"	148	2,100	8 1/16"	205	1/4"	3/8"	6.3	178	4.4	2.0	10/Ctn/19.0/1.2'
AT-2057R/H	0.401"	10	3/4"	19	6 1/4"	158	2,850	8 5/8"	220	1/4"	3/8"	4.5	120	4.0	1.8	10/Ctn/21.0/1.2'
AT-2051R/H	0.401"	10	3/4"	19	5 3/5"	141	3,030	6 4/5"	170	1/4"	3/8"	4.5	120	3.3	1.5	10/Ctn/17.0/0.8'
AT-2061R/H	0.401"	10	3/4"	19	5 3/5"	141	3,000	6 4/5"	170	1/4"	3/8"	4.0	115	4.0	1.8	10/Ctn/21.0/0.7'
AT-2062R/H	0.401"	10	3/4"	19	7"	178	2,100	8 1/3"	210	1/4"	3/8"	4.5	120	4.6	2.1	10/Ctn/24.0/0.8'
AT-2190R/H	0.401"	10	3/4"	19	1 5/8"	41	3,000	8 1/16"	205	1/4"	3/8"	5.5	157	4.2	1.9	10/Ctn/17.0/0.7'

AIR CHIPPING & RIVETING HAMMER

AT-2101/R&H
1" CHIPPING HAMMER ROUND OR HEX



AT-2103/R&H
3" CHIPPING HAMMER ROUND OR HEX

AT-2102/R&H
2" CHIPPING HAMMER ROUND OR HEX

AT-2104/R&H
4" CHIPPING HAMMER ROUND OR HEX

Model No.	Chisel Shank(in.)		Bore Diameter		Piston Stroke Length		Blow Per Min (BPM)	Overall Length		Air Inlet (PT)	Air Hose (ID)	Avg-Air Cons.		Net Weight		Packing Pcs/Ctn/G.W./Cuft (kgs)
	Round	Hex	in.	mm	in.	mm		in.	mm			CFM	l/min	lbs	kgs.	
AT-2101/R&H	0.68" (17mm)	0.58" (14.7mm)	1"	25.4	1-1/8"	28.6	2820	12 1/8"	308	3/8"	1/2"	21	600	12.1	5.5	2/Ctn/15.7/0.9'
AT-2102/R&H	0.68" (17mm)	0.58" (14.7mm)	2"	51	1-1/8"	28.6	2400	12 7/8"	327	3/8"	1/2"	21	600	13.0	5.9	2/Ctn/15.9/1.0'
AT-2103/R&H	0.68" (17mm)	0.58" (14.7mm)	3"	76	1-1/8"	28.6	1920	14 7/8"	378	3/8"	1/2"	25	700	14.3	6.5	2/Ctn/16.9/1.1'
AT-2104/R&H	0.68" (17mm)	0.58" (14.7mm)	4"	102	1-1/8"	28.6	1500	16 1/8"	410	3/8"	1/2"	28	800	15.4	7.0	2/Ctn/19.0/1.1'

AT-2201
1" RIVETING HAMMER

AT-2202
2" RIVETING HAMMER

AT-2203
3" RIVETING HAMMER

AT-2204
4" RIVETING HAMMER

AT-2205
5" RIVETING HAMMER

AT-2207
7" RIVETING HAMMER

AT-2209
9" RIVETING HAMMER



AT-2201S
1" RIVETING HAMMER

AT-2202S
2" RIVETING HAMMER

AT-2203S
3" RIVETING HAMMER

AT-2204S
4" RIVETING HAMMER

Model No.	Chisel Shank		Capacity Cold Rivets Dural Steel		Bore and stroke		Free Speed (BPM)	Air Consumption		Air Inlet (PT)	Air Hose (ID)	Net Weight		Packing Pcs/Ctn/G.W./Cuft (kgs)
	in.	mm	in.	mm	in.	mm		CFM	l/min			lbs	kgs.	
AT-2201	0.401	10	5/32 (1/8)	4.0(3.2)	9/16 x 1-3/8	14.3 x 35.0	2850	10.6	300	1/4"	3/8"	2.2	1.0	10/Ctn/13/1.16'
AT-2202	0.401	10	3/32(1/8)	2.4 (3.2)	1/2 x 2-1/4	12.7 x 57.2	2600	12.4	350	1/4"	3/8"	2.6	1.2	10/Ctn/15.5/1.16'
AT-2203	0.401	10	5/32(3/16)	4.0 (4.8)	1/2 x 2-7/8	12.7 x 73.0	2200	12.4	350	1/4"	3/8"	2.8	1.3	10/Ctn/16.5/1.16'
AT-2204	0.401	10	1/4 (3/16)	6.4 (4.8)	1/2 x 3-1/16	12.7 x 77.8	1800	12.4	350	1/4"	3/8"	3.1	1.4	10/Ctn/17.5/1.16'
AT-2205	0.498	12.65	1/4 (3/16)	6.4 (4.8)	3/4 x 2-11/16	19.1 x 68.3	1560	15.8	450	1/4"	3/8"	4.8	2.2	10/Ctn/26.0/1.66'
AT-2207	0.498	12.65	5/16 (1/4)	7.9 (6.4)	3/4 x 3-7/8	19.1 x 98.4	1140	15.8	450	1/4"	3/8"	5.1	2.3	10/Ctn/28.0/1.66'
AT-2209	0.498	12.65	3/8 (5/16)	9.5 (7.9)	3/4 x 5-13/16	19.1 x 147.6	900	15.8	450	1/4"	3/8"	5.9	2.7	10/Ctn/30.5/1.66'
AT-2201S	0.401	10	5/32 (1/8)	4.0 (3.2)	9/16 x 1-3/8	14.3 x 35.0	2850	10.6	300	1/4"	3/8"	2.2	1.0	10/Ctn/10.5/0.7'
AT-2202S	0.401	10	3/32 (1/8)	2.4 (3.2)	1/2 x 2-1/4	12.7 x 57.2	2580	12.35	350	1/4"	3/8"	2.6	1.2	10/Ctn/12/0.7'
AT-2203S	0.401	10	5/32 (3/16)	4.0 (4.8)	1/2 x 2-7/8	12.7 x 73.0	2160	12.35	350	1/4"	3/8"	2.8	1.3	10/Ctn/13/0.7'
AT-2204S	0.401	10	1/4 (3/16)	6.4 (4.8)	1/2 x 3-1/16	12.7 x 77.8	1740	12.35	350	1/4"	3/8"	3.1	1.4	10/Ctn/14/0.82'

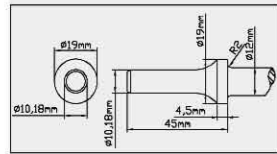
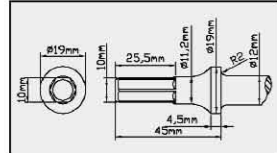
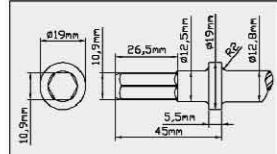
CHISEL FOR AIR HAMMER (page37.38)
A. ROUND Ø12MM / (0.401") 10.18MM

B. HEX Ø12MM / 10MM

C. HEX Ø12MM / 11MM

TAPERED PUNCH

SIZE	LENGTH	120-125MM (5")	170-175mm(7")
Round φ 10.18mm (0.401")		AT-2003/R01A1	AT-2003/R01A2
Hex φ 10 mm		AT-2003/H01B1	AT-2003/H01B2
Hex φ 11mm		AT-2003/HA01C1	AT-2003/HA01C2

FLAT CHISEL

SIZE	LENGTH	120-125MM (5")	170-175mm(7")
Round φ 10.18mm (0.401")		AT-2003/R02A1	AT-2003/R02A2
Hex φ 10 mm		AT-2003/H02B1	AT-2003/H02B2
Hex φ 11mm		AT-2003/HA02C1	AT-2003/HA02C2

SPOT WELD BRACKET

SIZE	LENGTH	120-125MM (5")	170-175mm(7")
Round φ 10.18mm (0.401")		AT-2003/R03A1	AT-2003/R03A2
Hex φ 10 mm		AT-2003/H03B1	AT-2003/H03B2
Hex φ 11mm		AT-2003/HA03C1	AT-2003/HA03C2

SING CUT PANEL CUTTER

SIZE	LENGTH	120-125MM (5")	170-175mm(7")
Round φ 10.18mm (0.401")		AT-2003/R04A1	AT-2003/R04A2
Hex φ 10 mm		AT-2003/H04B1	AT-2003/H04B2
Hex φ 11mm		AT-2003/HA04C1	AT-2003/HA04C2

SPOT WELD BRACKET

SIZE	LENGTH	120-125MM (5")	170-175mm(7")
Round φ 10.18mm (0.401")		AT-2003/R05A1	AT-2003/R05A2
Hex φ 10 mm		AT-2003/H05B1	AT-2003/H05B2
Hex φ 11mm		AT-2003/HA05C1	AT-2003/HA05C2

MUFFLER CUTTER

SIZE	LENGTH	120-125MM (5")	170-175mm(7")	245-250mm (10")	400-405mm(16")
Round φ 10.18mm (0.401")		AT-2003/R08A1	AT-2003/R08A2	AT-2003/R08A3	AT-2003/R08A4
Hex φ 10 mm		AT-2003/H08B1	AT-2003/H08B2	AT-2003/H08B3	AT-2003/H08B4
Hex φ 11mm		AT-2003/HA08C1	AT-2003/HA08C2	AT-2003/HA08C3	AT-2003/HA08C4

SHEET METAL TRIMMER

SIZE	LENGTH	120-125MM (5")	170-175mm(7")	245-250mm (10")	400-405mm(16")
Round φ 10.18mm (0.401")		AT-2003/R09A1	AT-2003/R09A2	AT-2003/R09A3	AT-2003/R09A4
Hex φ 10 mm		AT-2003/H09B1	AT-2003/H09B2	AT-2003/H09B3	AT-2003/H09B4
Hex φ 11mm		AT-2003/HA09C1	AT-2003/HA09C2	AT-2003/HA09C3	AT-2003/HA09C4

30MM WIDE FLAT

SIZE	LENGTH	120-125MM (5")	170-175mm(7")	245-250mm (10")	400-405mm(16")
Round φ 10.18mm (0.401")		AT-2003/R10A1	AT-2003/R10A2	AT-2003/R10A3	AT-2003/R10A4
Hex φ 10 mm		AT-2003/H10B1	AT-2003/H10B2	AT-2003/H10B3	AT-2003/H10B4
Hex φ 11mm		AT-2003/HA10C1	AT-2003/HA10C2	AT-2003/HA10C3	AT-2003/HA10C4

30MM WIDE BENT CHISEL

SIZE	LENGTH	120-125MM (5")	170-175mm(7")	245-250mm (10")	400-405mm(16")
Round φ 10.18mm (0.401")		AT-2003/R11A1	AT-2003/R11A2	AT-2003/R11A3	AT-2003/R11A4
Hex φ 10 mm		AT-2003/H11B1	AT-2003/H11B2	AT-2003/H11B3	AT-2003/H11B4
Hex φ 11mm		AT-2003/HA11C1	AT-2003/HA11C2	AT-2003/HA11C3	AT-2003/HA11C4

PANEL CUTTER

SIZE	LENGTH	120-125MM (5")	170-175mm(7")	245-250mm (10")	400-405mm(16")
Round φ 10.18mm (0.401")		AT-2003/R12A1	AT-2003/R12A2	AT-2003/R12A3	AT-2003/R12A4
Hex φ 10 mm		AT-2003/H12B1	AT-2003/H12B2	AT-2003/H12B3	AT-2003/H12B4
Hex φ 11mm		AT-2003/HA12C1	AT-2003/HA12C2	AT-2003/HA12C3	AT-2003/HA12C4

DOUBLE EDGE CUTTER

SIZE	LENGTH	120-125MM (5")	170-175mm(7")	245-250mm (10")	400-405mm(16")
Round φ 10.18mm (0.401")		AT-2003/R13A1	AT-2003/R13A2	AT-2003/R13A3	AT-2003/R13A4
Hex φ 10 mm		AT-2003/H13B1	AT-2003/H13B2	AT-2003/H13B3	AT-2003/H13B4
Hex φ 11mm		AT-2003/HA13C1	AT-2003/HA13C2	AT-2003/HA13C3	AT-2003/HA13C4

SHEET METAL CUTTER

SIZE	LENGTH	120-125MM (5")	170-175mm(7")	245-250mm (10")	400-405mm(16")
Round φ 10.18mm (0.401")		AT-2003/R14A1	AT-2003/R14A2	AT-2003/R14A3	AT-2003/R14A4
Hex φ 10 mm		AT-2003/H14B1	AT-2003/H14B2	AT-2003/H14B3	AT-2003/H14B4
Hex φ 11mm		AT-2003/HA14C1	AT-2003/HA14C2	AT-2003/HA14C3	AT-2003/HA14C4

40MM WIDE CUTTING CHISEL

SIZE	LENGTH	120-125MM (5")	170-175mm(7")	245-250mm (10")	400-405mm(16")
Round φ 10.18mm (0.401")		AT-2003/R18A1	AT-2003/R18A2	AT-2003/R18A3	AT-2003/R18A4
Hex φ 10 mm		AT-2003/H18B1	AT-2003/H18B2	AT-2003/H18B3	AT-2003/H18B4
Hex φ 11mm		AT-2003/HA18C1	AT-2003/HA18C2	AT-2003/HA18C3	AT-2003/HA18C4

HAMMER CHISEL

SIZE	LENGTH	120-125MM (5")	170-175mm(7")	245-250mm (10")	400-405mm(16")
Round φ 10.18mm (0.401")		AT-2003/R20A1	AT-2003/R20A2	AT-2003/R20A3	AT-2003/R20A4
Hex φ 10 mm		AT-2003/H20B1	AT-2003/H20B2	AT-2003/H20B3	AT-2003/H20B4
Hex φ 11mm		AT-2003/HA20C1	AT-2003/HA20C2	AT-2003/HA20C3	AT-2003/HA20C4

TAPERED PUNCH

SIZE	LENGTH	120-125MM (5")	170-175mm(7")	245-250mm (10")	400-405mm(16")
Round φ 10.18mm (0.401")		AT-2003/R22A1	AT-2003/R22A2	AT-2003/R22A3	AT-2003/R22A4
Hex φ 10 mm		AT-2003/H22B1	AT-2003/H22B2	AT-2003/H22B3	AT-2003/H22B4
Hex φ 11mm		AT-2003/HA22C1	AT-2003/HA22C2	AT-2003/HA22C3	AT-2003/HA22C4

SPOT BRACKET BENT

SIZE	LENGTH	120-125MM (5")	170-175mm(7")	245-250mm (10")	400-405mm(16")
Round φ 10.18mm (0.401")		AT-2003/R23A1	AT-2003/R23A2	AT-2003/R23A3	AT-2003/R23A4
Hex φ 10 mm		AT-2003/H23B1	AT-2003/H23B2	AT-2003/H23B3	AT-2003/H23B4
Hex φ 11mm		AT-2003/HA23C1	AT-2003/HA0923C2	AT-2003/HA23C3	AT-2003/HA23C4

16MM CUTTING CHISEL, LING BLADE, BENT

SIZE	LENGTH	120-125MM (5")	170-175mm(7")	245-250mm (10")	400-405mm(16")
Round φ 10.18mm (0.401")		AT-2003/R24A1	AT-2003/R24A2	AT-2003/R24A3	AT-2003/R24A4
Hex φ 10 mm		AT-2003/H24B1	AT-2003/H24B2	AT-2003/H24B3	AT-2003/H24B4
Hex φ 11mm		AT-2003/HA24C1	AT-2003/HA24C2	AT-2003/HA24C3	AT-2003/HA24C4

SHRED METAL TRIMMER

SIZE	LENGTH	120-125MM (5")	170-175mm(7")	245-250mm (10")	400-405mm(16")
Round φ 10.18mm (0.401")		AT-2003/R25A1	AT-2003/R25A2	AT-2003/R25A3	AT-2003/R25A4
Hex φ 10 mm		AT-2003/H25B1	AT-2003/H25B2	AT-2003/H25B3	AT-2003/H25B4
Hex φ 11mm		AT-2003/HA25C1	AT-2003/HA25C2	AT-2003/HA25C3	AT-2003/HA25C4



AT-6015
Hydraulic Riveter

- MAX CAPACITY: 4.8mm (3/16")
- JAW: 2PCS



AT-6015A
Hydraulic Riveter

- MAX CAPACITY: 4.8mm (3/16")
- JAW: 2PCS



AT-6016
H.D. Hydraulic Riveter

- MAX CAPACITY: 4.8mm (3/16")
- JAW: 3PCS



AT-6017
H.D. Hydraulic Riveter

- MAX CAPACITY: 6.4mm (1/4")
- JAW: 3PCS



AT-6030A
Composite H.D. Hydraulic Riveter

- MAX CAPACITY: 4.8mm (3/16")
- JAW: 3PCS



AT-6040A
Composite H.D. Hydraulic Riveter

- MAX CAPACITY: 6.4mm (1/4")
- JAW: 3PCS



AT-6015HA
H.D. Hydraulic Riveter

- MAX CAPACITY: 6.4mm (1/4")
- JAW: 2PCS



AT-6013
5/32" Riveter

- JAW: 2PCS



AT-6013A
3/16" Riveter

- JAW: 2PCS



AT-160ZQM
M6 Rivet Nut Gun

- COMPOSITE BODY
- QUICK CHANGE NOSE
- MAX RIVET NUT/SCREW CAP.: M6



Clutch Screwdriver

AT-4008
Adjustable Clutch Screwdriver

- 1,800RPM



AT-4018
Adjustable Clutch Screwdriver

- 800RPM



AT-4080E
1/4" External Clutch Adjustable Screwdriver

AT-4080AE
1/4" External Clutch Adjustable Screwdriver

AT-280ZQM
M8 Rivet Nut Gun

- COMPOSITE BODY
- QUICK CHANGE NOSE
- MAX RIVET NUT/SCREW CAP.: M8



AT-210ZQM
M10 Rivet Nut Gun

- COMPOSITE BODY
- QUICK CHANGE NOSE
- MAX RIVET NUT/SCREW CAP.: M10

AT-4080
Adjustable Clutch Screwdriver

- 1,800RPM



AT-4081
Adjustable Clutch Screwdriver

- 800RPM



AT-4053
1/4" Straight Clutch Screwdriver

AT-4054
1/4" Straight Clutch Screwdriver

Model No.	Blind Rivet Setting Capacity (in.)					Traction Power		Stroke Length		Overall Length		Air Inlet		Air Hose (ID)		Net Weight		Packing Pcs/Ctn/G.W./Cuft (kgs)
	2.4mm	3.2mm	4.0mm	4.8mm	6.4mm	Lbs	kgs	in.	mm	in.	mm	(PT)	(ID)	lbs	kgs.			
AT-6015	3/32"	1/8"	5/32"	(3/16")		1,950	885	9/16"	14	10 3/4"	273	1/4"	3/8"	3.3	1.5	10/Ctn/19.0/1.85'		
AT-6015A	3/32"	1/8"	5/32"	3/16"		2,200	1100	5/8"	15	10 5/16"	275	1/4"	3/8"	3.6	1.6	10/Ctn/23.0/2.10'		
AT-6015HA	3/32"	1/8"	5/32"	3/16"	1/4"	3,800	1750	11/16"	18	12 1/2"	320	1/4"	3/8"	4.3	2.0	6/Ctn/23.0/3.74'		
AT-6030A		1/8"	5/32"	3/16"		2,400	1100	11/16"	8	11 15/16"	288	1/4"	3/8"	3.0	1.3	6/Ctn/16.5/3.72'		
AT-6040A		1/8"	5/32"	3/16"	1/4"	3,500	1600	3/4"	19	11 3/4"	300	1/4"	3/8"	3.5	1.6	6/Ctn/17.0/3.72'		
AT-6017			5/32"	3/16"	1/4"	3,300	1500	11/16"	18	12 1/2"	320	1/4"	3/8"	5.3	2.4	6/Ctn/21.5/3.74'		
AT-6016		1/8"	5/32"	3/16"		1,985	900	5/8"	17	11 3/4"	300	1/4"	3/8"	3.3	1.5	10/Ctn/22.0/2.63'		
AT-6013	3/32"	1/8"	5/32"			900	400	3/4"	20	6 1/2"	165	1/4"	3/8"	0.9	2.0	10/Ctn/15.0/1.50'		
AT-6013A	3/32"	1/8"	5/32"	3/16"		1,300	591	3/8"	10	9"	288	1/4"	3/8"	3.3	1.5	10/Ctn/16.0/1.50'		

Model No.	Max Rivet Nut/ Screw Cap	Free Speed RPM	Air Inlet (PT)	Air Hose (ID)	Avg-Air Consumption		Net Weight		Packing Pcs/Ctn/G.W./Cuft (kgs)
					CFM	l/min	lbs	kgs.	
AT-160ZQM	M6	1,500	1/4"	3/8"	9.9	280	2.4	1.1	10/Ctn/17.0/1.9'
AT-280ZQM	M8	500	1/4"	3/8"	9.2	260	2.4	1.1	10/Ctn/17.0/1.9'
AT-210ZQM	M10	280	1/4"	3/8"	9.9	280	3.1	1.4	10/Ctn/18.5/2.1'

Model No.	HEX.Shank Size		Free Speed RPM	Torque		Overall Length		Air Inlet (PT)	Air Hose (ID)	Avg-Air Consumption		Net Weight		Packing Pcs/Ctn/G.W./Cuft (kgs)
	in.	mm		in-lbs	n-m	in.	mm			CFM	l/min	lbs	kgs.	
AT-4018	1/4"	6.35	1,800	20-115	2.3-13.0	7 3/4"	195	1/4"	3/8"	4	113	2.6	1.2	10/Ctn/17.0/1.1'
AT-4008	1/4"	6.35	800	45-145	5.0-16.4	8 1/4"	210	1/4"	3/8"	4	113	2.6	1.2	10/Ctn/17.0/1.2'
AT-4081	1/4"	6.35	800	45-145	5.0-16.4	7"	178	1/4"	3/8"	5	142	2.5	1.1	10/Ctn/14.0/0.9'
AT-4080	1/4"	6.35	1,800	20-115	2.3-13.0	7"	178	1/4"	3/8"	5	142	2.5	1.1	10/Ctn/14.0/0.9'
AT-4080E	1/4"	6.35	1,800	20-115	2.3-13.0	8 1/2"	215	1/4"	3/8"	3	85	2.7	1.2	10/Ctn/14.0/0.9'
AT-4080AE	1/4"	6.35	700	45-145	5.0-16.4	8 5/8"	220	1/4"	3/8"	5	142	2.7	1.3	10/Ctn/14.0/0.9'
AT-4053	1/4"	6.35	1,800	20-115	2.3-13.0	10 3/8"	265	1/4"	3/8"	5	142	2.5	1.1	10/Ctn/11.0/1.1'
AT-4054	1/4"	6.35	800	45-145	5.0-16.4	11"	279	1/4"	3/8"	4	113	2.7	1.3	10/Ctn/13.0/1.3'

STRAIGHT TYPE



AT-3009STWA
1/4" Shut Off Screwdriver
- TORQUE CONTROL SHUT OFF TYPE
- BOLT CAP: 5MM



AT-5005STUA
1/4" Shut Off Screwdriver
- TORQUE CONTROL SHUT OFF TYPE
- BOLT CAP: 5-6MM



AT-3180H
1/4" Screwdriver
- TWO HAMMER
- BOLT CAP: 6-8MM



AT-3213
1/4" Screwdriver
- DOUBLE HAMMER
- BOLT CAP: 4-5MM



AT-3155A
1/4" 90° Corner Screwdriver
- TWO HAMMER
- BOLT CAP: 6-8MM



AT-3040
1/4" 90° Corner Screwdriver

AT-3040W
3/8" 90° Corner Screwdriver
- TWO HAMMER
- BOLT CAP: 6-8MM

Model No.	HEX.Shank Size		Free Speed RPM	Torque		Overall Length		Air Inlet (PT)	Air Hose (ID)	Avg-Air Consumption		Net Weight		Packing Pcs/Ctn/G.W./Cuft (kgs)
	in.	mm		in-lbs	n-m	in.	mm			CFM	l/min	lbs	kgs.	
AT-3009STWA	1/4"	6.35	900	4.4-31	0.5-3.5	9 3/4"	247	1/4"	1/4"	2.1	59	1.68	0.76	20/Ctn/23.0/1.5'
AT-5005STUA	1/4"	6.35	480	44-92.4	5-10.5	9 1/2"	240	1/4"	1/4"	17.5	496	2.2	1.0	20/Ctn/24.0/1.5'
AT-3180H	1/4"	6.35	9,000	300	34	8"	208	1/4"	1/4"	5.6	160	2.2	1.0	20/Ctn/24.5/1.4'
AT-3213	1/4"	6.35	10,000	415	47	8 5/8"	220	1/4"	1/4"	4.5	120	1.8	0.8	20/Ctn/16.0/1.1'
AT-3155A	1/4"	6.35	7,000	133	20	8"	205	1/4"	1/4"	4.3	120	2.0	0.9	20/Ctn/20.0/1.0'
AT-3040	1/4"	6.35	8,000	239-283	37-43	8 7/16"	217	1/4"	1/4"	5.6	160	2.86	1.3	12/Ctn/18.5/0.91'
AT-3040W	3/8"	9.50	8,000	336-380	52-57	8 7/16"	217	1/4"	1/4"	5.6	160	2.86	1.3	12/Ctn/18.5/0.91'

PISTOL TYPE



AT-3160
1/4" Super Duty Screwdriver
- TWIN HAMMER
- BOLT CAP: 6-8MM



AT-3030
1/4" Super Duty Screwdriver
- TWO HAMMER
- BOLT CAP: 6-8MM



AT-3050
1/4" Super Ultra Duty Screwdriver
- TWIN HAMMER
- BOLT CAP: 6-8MM



AT-3052
1/4" Super Ultra Duty Screwdriver
- TWIN HAMMER
- TORQUE ADJUSTABLE
- BOLT CAP: 12MM



AT-3410A
1/4" Super Ultra Duty Screwdriver
- TWIN HAMMER
- BOLT CAP: 10MM



AT-3430A
3/8" Super Ultra Duty Screwdriver
- ROKING CLUTCH
- BOLT CAP: 10MM

Model No.	HEX.Shank Size		Free Speed RPM	Torque		Overall Length		Air Inlet (PT)	Air Hose (ID)	Avg-Air Consumption		Net Weight		Packing Pcs/Ctn/G.W./Cuft (kgs)
	in.	mm		in-lbs	n-m	in.	mm			CFM	l/min	lbs	kgs.	
AT-3160	1/4"	6.35	10,000	487	55	7"	180	1/4"	1/4"	4.9	140	2.64	1.2	12/Ctn/18.5/1.10'
AT-3030	1/4"	6.35	8,000	442-504	50-57	6 3/4"	172	1/4"	1/4"	5.6	160	2.42	1.1	10/Ctn/13.0/0.93'
AT-3050	1/4"	6.35	8,000	513-531	58-60	6"	154	1/4"	1/4"	4.6	130	2.64	1.2	10/Ctn/14.5/0.83'
AT-3052	1/4"	6.35	12,000	1681	190	5 2/3"	145	1/4"	3/8"	5.6	10	3.52	1.6	10/Ctn/18.0/0.80'
AT-3410A	1/4"	6.35	8,500	1593	180	8"	210	1/4"	3/8"	5.5	156	2.4	1.1	10/Ctn/13.0/1.0'
AT-3430A	3/8"	9.5	8,000	1200	136	6"	152	1/4"	3/8"	5.5	156	2.9	1.3	20/Ctn/26/1.5'

HOSE REEL

- WORKING PRESSURE: 15 Bar
- HOSE LENGTH (INLET) : 50CM
- HOSE LENGTH (OUTLET) : 10~15M
- PU BRAID



Item No.	description
HR04-UB6510	6.5MM X 10MM X 10M (PU BRAID) 1/4" + 1/4"
HR04-UB6515	6.5MM X 15MM X 15M (PU BRAID) 1/4" + 1/4"
HR04-UB8010	8.0MM X 12MM X 10M (PU BRAID) 1/4" + 1/4"
HR04-UB8012	8.0MM X 12MM X 12M (PU BRAID) 1/4" + 1/4"
HR04-UB8015	8.0MM X 12MM X 15M (PU BRAID) 1/4" + 1/4"
HR04-UB9510	9.5MM X 14.5MM X10M (PU BRAID) 3/8" + 3/8"
HR04-UB9512	9.5MM X 14.5MM X 12M (PU BRAID) 3/8" + 3/8"
HR04-UB1010	10MM X 15MM X 10M (PU BRAID) 3/8" + 3/8"

AA-2005

- PU/ PU BRAID
- WORKING PRESSURE: 8 BAR
- BURSTING PRESSURE: 24 BAR
- 5MM X 8MM X 7.5M (1/4" +1/4")



AA-2005A

- PU/ PU BRAID
- WORKING PRESSURE: 8 BAR
- BURSTING PRESSURE: 24 BAR
- 6.5MM X 10MM X 6M (1/4" +1/4")

HOSE REEL

- WORKING PRESSURE: 15 BAR
- BURSTING PRESSURE: 60 BAR



Item No.	description
HR02-UB6520	6.5MM X 10MM X 20M (PU BRAID) 1/4" + 1/4"
HR02-UB6530	6.5MM X 10MM X 30M (PU BRAID) 1/4" + 1/4"
HR02-UB6540	6.5MM X 10MM X 40M (PU BRAID) 1/4" + 1/4"
HR02-UB6550	6.5MM X 10MM X 50M (PU BRAID) 1/4" + 1/4"
HR02-UB8020	8.0MM X 12MM X 20M (PU BRAID) 1/4" + 1/4"
HR02-UB8030	8.0MM X 12MM X 30M (PU BRAID) 1/4" + 1/4"
HR02-UB8040	8.0MM X 12MM X 40M (PU BRAID) 1/4" + 1/4"
HR02-UB8520	8.5MM X 12.5MM X 20M (PU BRAID) 1/4" + 1/4"
HR02-UB8530	8.5MM X 12.5MM X 30M (PU BRAID) 1/4" + 1/4"
HR02-UB8540	8.5MM X 12.5MM X 40M (PU BRAID) 1/4" + 1/4"
HR02-UB9520	9.5MM X 14.5MM X 20M (PU BRAID) 3/8" + 3/8"
HR02-UB9525	9.5MM X 14.5MM X 25M (PU BRAID) 3/8" + 3/8"
HR02-UB9530	9.5MM X 14.5MM X 30M (PU BRAID) 3/8" + 3/8"
HR02-UB1020	10MM X 15MM X 20M (PU BRAID) 3/8" + 3/8"
HR02-UB1030	10MM X 15MM X 30M (PU BRAID) 3/8" + 3/8"
HR02-UB1130	11MM X 16MM X 30M (PU BRAID) 3/8" + 3/8"

HOSE REEL

- WORKING PRESSURE: 15 BAR
- BURSTING PRESSURE: 60 BAR



Item No.	description
HR07-UB6520	6.5MM X 10MM X 20M (PU BRAID) 1/4" + 1/4"
HR07-UB6525	6.5MM X 10MM X 25M (PU BRAID) 1/4" + 1/4"
HR07-UB6530	6.5MM X 10MM X 30M (PU BRAID) 1/4" + 1/4"
HR07-UB8010	8.0MM X 12MM X 10M (PU BRAID) 1/4" + 1/4"
HR07-UB8015	8.0MM X 12MM X 15M (PU BRAID) 1/4" + 1/4"
HR07-UB8020	8.0MM X 12MM X 20M (PU BRAID) 1/4" + 1/4"
HR07-UB9510	9.5MM X 14.5MM X 10M (PU BRAID) 3/8" + 3/8"
HR07-UB9515	9.5MM X 14.5MM X 15M (PU BRAID) 3/8" + 3/8"
HR07-UB9520	9.5MM X 14.5MM X 20M (PU BRAID) 3/8" + 3/8"

REINFORCED HOSE

- WORKING PRESSURE: 20 BAR
- BURSTING PRESSURE: 80 BAR



Item No.	description
AA-1012T	6.4*11.4*10M TUNDRA PVC W/1/4" THREAD
AA-1012H	6.4*11.4*10M HI-NET PVC W/1/4" THREAD
AA-1013T	9.7*15.5*10M TUNDRA PVC W/1/4" THREAD
AA-1013H	9.7*15.5*10M HI-NET PVC W/1/4" THREAD
AA-1014T	12.7*18.7*10M TUNDRA PVC W/3/8" THREAD
AA-1014H	12.7*18.7*10M HI-NET PVC W/3/8" THREAD

PU RECOIL HOSE



Item No.	description
AA-5806	5*8mm*6M Shrink
AA-5806-C	5*8mm*6M clam shell
AA-58075	5*8mm*7.5M Shrink
AA-58075-C	5*8mm*7.5M clam shell
AA-5809	5*8mm*9M Shrink
AA-5809-C	5*8mm*9M clam shell
AA-5810	5*8mm*10M Shrink
AA-5810-C	5*8mm*10M clam shell
AA-5815A	5*8mm*15M Shrink
AA-5815A-C	5*8mm*15M clam shell
AA-659506	6.5*9.5mm*6M Shrink
AA-6595075	6.5*9.5mm*7.5M Shrink
AA-659509	6.5*9.5mm*9M Shrink
AA-659510	6.5*9.5mm*10M Shrink
AA-659515	6.5*9.5mm*15M Shrink
AA-81206	8*12mm*6M Shrink
AA-812075	8*12mm*7.5M Shrink
AA-81209	8*12mm*9M Shrink
AA-81210	8*12mm*10M Shrink
AA-81215	8*12mm*15M Shrink

AA-4704FR 1/2" Filter & Regulator



AA-4704 1/2" Filter Regulator & Lubricator



AA-6706 3/4" Filter Regulator & Lubricator



AA-1010MFR 1/4" Filter & Regulator

AA-1010M 1/4" Filter, Regulator & Lubricator



AA-2010MFR 3/8" Filter & Regulator

AA-2000M 3/8" Filter, Regulator & Lubricator

AA-2010M 3/8" Control Unit

AA-2000FR 1/2" Filter & Regulator

AA-2010 1/2" Filter, Regulator & Lubricator

AA-2000 1/2" Control Unit



AA-4704FR&L 1/2" Filter & Regulator

- W/ LUBRICATOR

AA-6906(A) 3/4" Filter Regulator & Lubricator

A: auto drain option

AA-8908(A) 1" Filter Regulator & Lubricator

- HEAVY DUTY TYPE



Model No.	FILTER SCREEN MICRO (u)	MAX INPUT PRESSURE (PSI)	MAX OUTPUT PRESSURE (PSI)	MAX DROPPED FLOW (l/min)	OPERATION TEMPERATURE	DRAIN CAPACITY (ml)	OIL CAPACITY (ml)
AA-4704FR	5u	250	7-215	4000	5°C - 60°C	80ml	150ml
AA-4704FR&L	5u	250	7-215	4000	5°C - 60°C	80ml	150ml
AA-4704	5u	250	7-215	4000	5°C - 60°C	80ml	150ml
AA-6706	5u	250	7-215	4000	5°C - 60°C	80ml	150ml
AA-6906 (A)	5u	250	225	4600	5°C - 60°C	300ml	350ml
AA-8908 (A)	5u	250	225	5200	5°C - 60°C	300ml	350ml
AA-1010MFR	5-50u	140	140	980	5°C - 50°C	-	40ml
AA-2010MFR	5-50u	140	140	980	5°C - 50°C	-	40ml
AA-2000FR	5-50u	140	140	980	5°C - 50°C	-	40ml
AA-1010M	5-50u	140	140	1200	5°C - 50°C	40ml	120ml
AA-2000M	5-50u	140	140	1200	5°C - 50°C	40ml	120ml
AA-2010	5-50u	140	140	1200	5°C - 50°C	40ml	120ml
AA-2010M	5-50u	140	140	1250	5°C - 50°C	120ml	120ml
AA-2000	5-50u	140	140	1250	5°C - 50°C	120ml	120ml

SPRING BALANCER

ACCESSORIES



AA-2003T

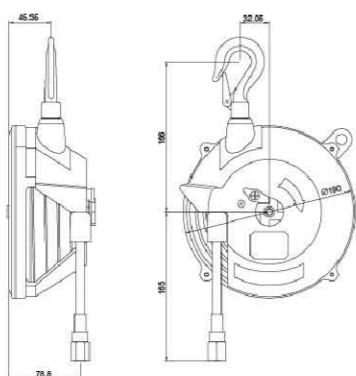

AA-2004T



AA-2005T



AA-2003B



AA-2004A
AA-2004B
AA-2008



AA-2011
AA-2015



AA-2015B
AA-2022

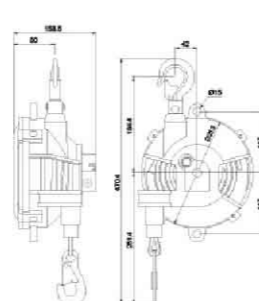
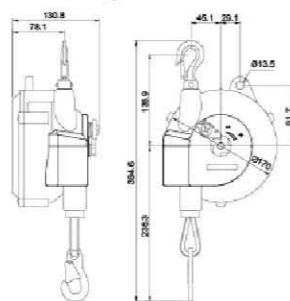
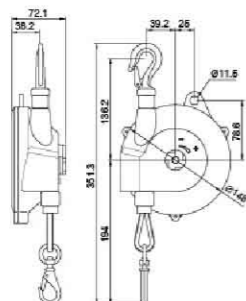
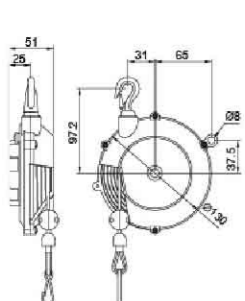

MODEL	CAPACITY (kg)	WEIGHT (kg)	TRAVEL (m)	HOSE MATERIAL(mm)	HOSE DIA (mm)	Q'TY (Ctn)	G.W./Ctn (kg)	CUFT (Ctn)
AA-2003T	0.5-1.5	1.8	1.4	Polyurethane	6.5x10.0	6	11.7	1.9
AA-2004T	1.5-3.0	1.9	1.4	Polyurethane	6.5x10.0	6	12.4	1.9
AA-2005T	3.0-5.0	2.0	1.4	Polyurethane	6.5x10.0	6	13.0	1.9

MODEL	CAPACITY (kg)	WEIGHT (kg)	TRAVEL (m)	POPE OPTION (mm)	ROPE DIA (mm)	Q'TY (Ctn)	G.W./Ctn (kg)	CUFT (Ctn)
AA-2003B	0.5-1.5	0.73	1.3	Cable	2	20	15.6	1.9
AA-2004A	1.5-3.0	1.73	1.3	Cable	3.2	10	18.3	1.7
AA-2004B	3.0-5.0	1.82	1.3	Cable	3.2	10	19.2	1.7
AA-2008	5.0-7.0	1.85	1.3	Cable	3.2	10	19.5	1.7
AA-2011	5.0-9.0	3.59	1.3	Cable	4.0	4	15.36	1.9
AA-2015	9.0-15.0	3.61	1.3	Cable	4.0	4	15.44	1.9
AA-2015B	15.0-22.0	7.7	1.5	Cable	4.8	3	24	2.5
AA-2022	22.0-30.0	8.3	1.5	Cable	4.8	3	26	2.5



AA-5006
Blow Gun (100mm-Tube)

AA-5006-3
Blow Gun (300mm-Tube)

- PLASTIC / BRASS INLET



AA-3111
Blow Gun (3" Tube)

- ADJUSTABLE AIR FLOW
- BODY: NYLON
- ZINC ALLOY INLET: 1/4"



AA-5013
Blow Gun (4"~30" Tube)

- PLASTIC / BRASS INLET: 1/4"



AA-3110
Blow Gun (3" Tube)

- BODY: NYLON
- ZINC ALLOY INLET: 1/4"

AA-3110-14
Blow Gun (14" Tube)



AA-503
Standard Tip Duster Gun



AA-3860B
High Flow Blower

- MATERIAL: ALUMINIUM
- MAX. PRESSURE: 250 PSI
- AIR FLOW: 6 SCFM @125PSI
- AIR INLET: 3/8"



AA-6101
Digital Tire Inflator
3-Function Tire Gauge



AA-6102
Digital Tire Inflator



AA-6103
Digital Tire Inflator



AA-6000
3 in 1 Tire Inflator W/Gauge



AA-6105
Digital Tire Inflator W/Gauge

- LONG RUBBER HOSE : 50CM



AA-6106
3-Function Tire Gauge



AA-6005
3 in 1 Tire Inflator W/Gauge
- PEM TYPE



AA-6005B
3 in 1 Tire Inflator W/Gauge
- PEM TYPE



R2000
1/4" Regulator



R3000
1/4" Regulator



AA-322
1/4" Swivel Connector

AA-323
3/8" Swivel Connector



AA-2001
1/4" Regulator



AA-3040
1/4" Mini Oiler

AA-3030A
3/8" Mini Oiler



AA-3040B
OIL CUP 1/4"x2"



G-10
10pcs Grinder Stones Set
- SIZE : 1/4" / 6MM



AA-5005
Wonder Gun-Blow & Suck



AA-3062 **AA-3061**



AA-2001DZL
In Line Digital Regulator
- BODY: ZINC



AA-5009AB
Pocket Blow Gun
- TYPE AVILABLE VARIETY



AA-5119
Air Vacuum And Blower Gun Kit
- BODY: NYLON COMPOSITE
- SPECIFICATION:
Composite
Body Gun x1
Extension tube x 2
Brush (ABS) x 1
Flat Tube (PP) x 1
Tiny (ABS) x 1
Dust Bag x 1



AA-3080
Engine Cleaning Gun



AA-8400
Air Snow Gun



AA-8400K
Air Multi- Purpose Clean Kit



RK-1000
REPAIR KIT
- FOR BEARING OF SANDER



Model	Valcro Pad Size		Stick-on Pad Size	
	5"	6"	5"	6"
P-A	P-A5VC	P-A6VC	P-A5C	P-A6C
P-B	P-B5VC	P-B6VC	P-B5C	P-B6C
P-C			P-C5C	P-C6C
P-D			P-D5C	P-D6C



P-B2VC
2" VALCRO PAD
P-B3VC
3" VALCRO PAD
P-B35VC
3.5" VALCRO PAD



P-D0407
85mm Buffing Mop



SP-6M14
6" Sponge Pad (Course)
Suit For 1,500-1,800Rpm



QC-2A



QC-3A



QC-2B



P-B5VC6
5" VALCRO PAD W/6HOLE

P-B6VCA
6" VALCRO PAD W/6HOLE



AA-5000A
Engine Cleaning Gun



AA-5000
Engine Cleaning Gun



AA-8300
Air Snow Gun



AA-8200
Air Twister Cleaning Gun



S-002
Suction Cup
- CAPACITY : 40KGS



S-001
Suction Cup Set
- CAPACITY : 160KGS



PS-811
PAINT SHAKER



P-305D
6 Pcs 3" Scotchbrite Disc Set

P-205D
6 Pcs 2" Scotchbrite Disc Set



P-305K
6 Pcs 3" Sanding Disc Set

P-205K
6 Pcs 2" Sanding Disc Set

ACCESSORIES



Item	Part No.	Description
Saw Blade For Body Saw	P.No.147,187,247,327	
Drill Bit For Spot Grinder	P.No.5446 - 8mm, 3302 - 1/8", 3303 - 6mm, 3304 - 3mm	
Collect For Die Grinder	P.No.2734	3" Cutting Wheel (For AT-6027)
Rubber Pad	P.No.3434 (For AT-6034)	
Rubber Pad	P.No.3434A (For AT-6034)	
For AT-6020, AT-6021	P.No.6020	
For AT-6020, AT-6021	P.No.6021	
Backing Plate	P.No.1228 - 3", 1229 - 4 1/2", 1230 - 5 1/2"	

SPRAY GUN

BRUSH KIT

AS-1001S
Spray Gun



AS-1040N
Spray Gun



AS-1200
Spray Gun



AS-1000M
Middle Pressure Spray gun



AS-1000MS
Middle Pressure Spray gun



AS-1000HVLP
H.V.L.P. Spray Gun



AS-1005A
Mini Spray Gun



AS-1005E
HVLP Mini Spray Gun



Model No.	Feed Type	Standard Nozzle mm	Optional Nozzle mm	Capacity of Cup	Air Inlet (PT)	Air Hose (ID)	Avg-Air Consumption CFM	l/min	Net Weight lbs	kg.	Recomm. Air Pressure Psi	Kgs/Cm ²	Packing Pcs/Ctn/G.W./Cuft (kgs)
AS-1001S	Suction	1.3	1.0, 1.5, 1.8	0.6L	1/4"	1/4"	7.4-8.8	210-250	1.3	0.6	28-36	2.0-3.5	10/Ctn/11/1.6'
AS-1040N	Suction	1.6	1.0,1.5,1.8,2.0,2.5,3.0,3.5	1.0L	1/4"	3/8"	10-12.7	280-360	2.4	1.1	50-70	3.5-5.0	10/Ctn/12/2.2'
AS-1200	Suction	2.0	1.2,1.4,1.5,1.6,1.8,2.5	0.6L	1/4"	3/8"	12.7	360	1.3	0.6	43	2.9	10/Ctn/13/2.0'
AS-1000M	Suction	1.6	1.0,1.3,1.4,1.8,2.0,2.5	1.0L	1/4"	3/8"	10	280	1.8	0.82	35	2.5	10/Ctn/12/2.2'
AS-1000MS	Side	1.3	1.0,1.4,1.6,1.8,2.0,2.5	0.4L	1/4"	1/4"	10	280	1.4	0.64	29	2.0	10/Ctn/10/1.7'
AS-1000HVLP	Gravity	1.3	1.0,1.6,1.8,2.0	0.6L	1/4"	M16x1.5	12	350	1.3	0.6	21.75-29	1.5-2.0	10/Ctn/10/1.7'
AS-10005A	Gravity	1.0	0.5	0.145L	1/4"	1/4"	0.9	25	0.7	0.32	29	2.0	20/Ctn/9/1.5'
AS-1005E	Side	1.0	0.5,0.8,1.0,1.2,1.4	0.125L	1/4"	M10x1.0	4.1	115	0.7	0.32	29	2.0	20/Ctn/17/2.7'

AB-1002
Brush Kit

- 1 AIR BRUSH
- 2 GLASS JAR
- 1 AIR HOSE
- 1 ADAPTOR
- 1 HOLDER



Model No.	Feed Type	Nozzle Dia.	Neddle Dia.	Cup Capacity	Spanner
AB-1002	Suction	0.3mm	1.2mm	22&55cc	1 pc

Air Hose	Working Pressure	Pcs/Ctn	Carton Dimensions(cm)	N.W/G.W	Alternative Nozzle Size
plastic hose M5x0.45, 5FT	15-30 PSI	40	1.9'	18.3KG/19.3KG	0.2mm / 0.5mm

Double-action Trigger Air-paint Control.



AB-1183
Brush Kit



AB-1186
Brush Kit



AB-1203
Brush Kit

Model No.	Feed Type	Standard Nozzle Dia.	Cup Capacity	Working Pressure	Carton Dimensions (CM)	PCS/CTN	N.W./G.W.	Alternative Nozzle Size
AB-1183	Gravity	0.5mm	2&5&13cc	15-50psi	51x39x28	50	16.7KG/18.7KG	0.3mm/0.8mm
AB-1186	Gravity	0.3mm	2&5&13cc	15-50psi	44x38x30	30	12.0KG/14.0KG	0.2mm/0.25mm/0.5mm
AB-1203	Gravity	0.2mm	7cc	15-30psi	51x39x28	50	15.0KG/17.0KG	0.25mm/0.3mm/0.5mm



AB-1116K
Brush Kit



AB-1105K
Brush Kit

Model No.	Feed Type	Nozzle Dia.	Neddle Dia.	Nozzle Cap	Cup Capacity	Spanner	Air Hose	Regulator	Working Pressure	Pcs/Ctn	Carton Dimensions(cm)	N.W/G.W	Alternative Nozzle Size
AB-1105K	Gravity	1x 0.3mm 1x 0.5mm	1x 0.3mm 1x 0.5mm	1x 0.3mm 1x 0.5mm	1x20cc	1 pc	1x 1.8m (6ft)	1x G1/4-1/8	15-50 PSI	20	47x35x30	16KG/18KG	-
AB-1116K	Gravity	1x 0.3mm 1x 0.5mm	1x 0.3mm 1x 0.5mm	1x 0.3mm 1x 0.5mm	1x7cc 1x10cc	1 pc	1x 1.8m (6ft)	1x G1/4-1/8	15-50 PSI	20	47x35x30	16KG/18KG	0.2mm / 0.25mm / 0.5mm

MINI COMPRESSOR

COMPRESSOR



MA-1008
Mini Compressor



MA-1008-2
Mini Compressor



MA-1089A
Mini Compressor



MA-1025
Mini Compressor



MA-1040
Mini Compressor



MA-1040U
Mini Compressor

Model No.	Displacement l/min	HP	WORKING PRESSURE	MAX PRESSURE	AMP	RPM	WEIGHT (KG)	DIAMETER (mm)
MA-1008	20	1/6	90 PSI	4.5 kg/cm ²	-	1400	3.6 kg	300*170*215mm
MA-1008-2	20	1/6	90 PSI	4.5 kg/cm ²	-	1400	3.6 kg	295*165*260mm
MA-1089A	20	1/6	90 PSI	4.5 kg/cm ²	-	1400	8.4 kg	348*150*382mm
MA-1025	20	1/8	90 PSI	8 kg/cm ²	110V/1.4A; 220V/0.6A	1720	4.2 kg	260*140*215mm
MA-1040	42	1/6	90 PSI	8 kg/cm ²	110V/1.8A; 220V/0.9A	1720	4.8 kg	280*140*170mm
MA-1040U	42	1/6	90 PSI	8 kg/cm ²	110V/1.8A; 220V/0.9A	1720	7.7 kg	290*285*250mm

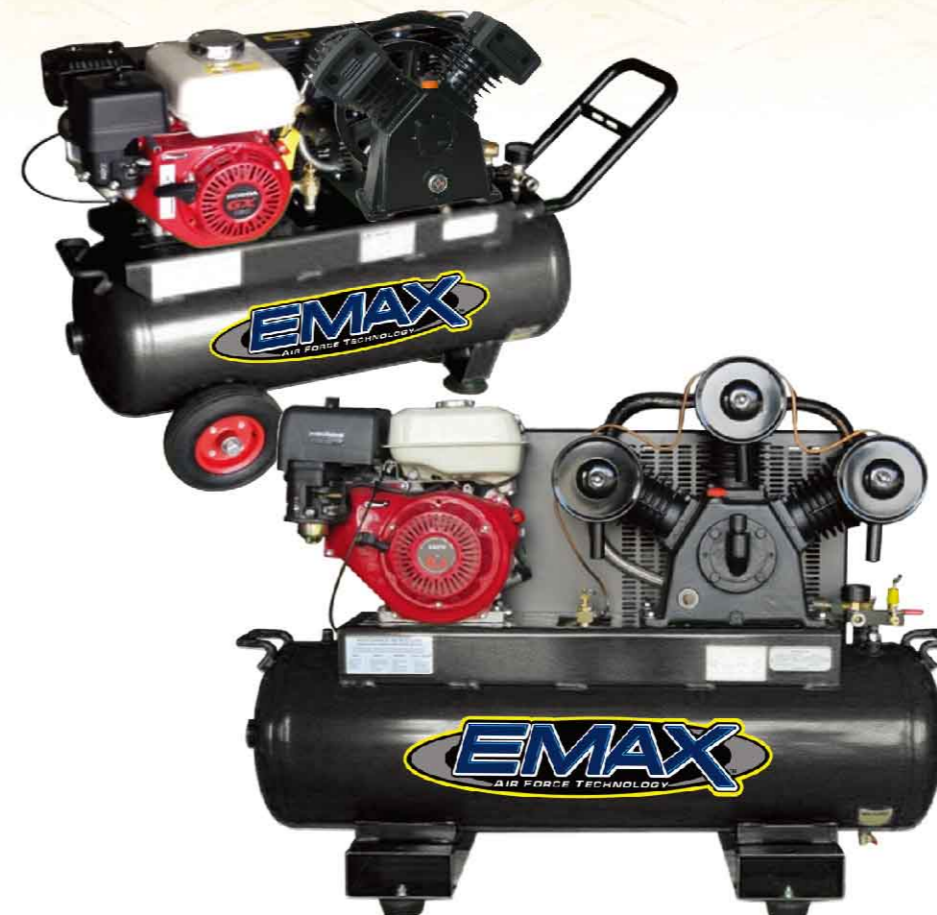

KOHLER PETROL



KOHLER DIESEL

HONDA

T& T ITEM NO.	BARE	DISP (L/MIN)	FAD CFM	FAD L/MIN	TANK	ENGINE
TB-5570PVH	65*46*2C (VA65)	320	11.3	225	70L	GX160 MANUAL
TB-5570PH	65*48*3C (TA65)	498	17.00	349	70L	GX160 MANUAL
TB-55120PH	65*48*3C (TA65)	498	17.00	349	112L	GX160 MANUAL
TB-55120PH(E)	65*48*3C (TA65)	498	17.00	349	112L	GX160 ELECTRIC
TB-80120PH	80*60*3C (TA80)	775	27.30	543	112L	GX270 ELECTRIC
TB-130160PH	100*70*3C (TA100)	1,361	48.00	1,138	160L	GX390 ELECTRIC

KOHLER PETROL

T& T ITEM NO.	BARE	DISP (L/MIN)	FAD CFM	FAD L/MIN	TANK	ENGINE
TB-5570PK	65*46*3C (TA65)	498	17.00	349	70L	CH270
TB-55120PK	65*48*3C (TA65)	498	17.00	349	112L	CH270
TB-80120PK	80*60*3C (TA80)	917	23.6	668	112L	CH395
TB-130160PK	100*70*3C (TA100)	1489	41.4	1172	160L	CH440

KOHLER DIESEL

T& T ITEM NO.	BARE	DISP (L/MIN)	FAD CFM	FAD L/MIN	TANK	ENGINE
TB-5570DV	65*46*2C (VA65)	320	11.3	225	70L	KD-225
TB-5570D	65*48*3C (TA65)	498	14.70	349	70L	KD-225
TB-55120D	65*48*3C (TA65)	498	14.70	349	112L	KD-225
TB-80120D	80*60*3C (TA80)	739	18.6	416	112L	KD-350
TB-130160DB	100*70*3C (TA100)	1,064	29	821	160L	KD-500

NITTO TYPE (BRASS)



QUICK COUPLER

Model No.	SIZE	Model No.	SIZE
A100-12F	1/4" F	A100-14M	1/2" M
A100-13F	3/8" F	A100-13H	3/8" H
A100-14F	1/2" F	A100-14H	1/2" H
A100-12M	1/4" M	A100-15H	5/16" H
A100-13M	3/8" M		



FEMALE PLUG

Model No.	SIZE
A100-22F	1/4" F
A100-23F	3/8" F
A100-24F	1/2" F



MALE PLUG

Model No.	SIZE
A100-32M	1/4" M
A100-33M	3/8" M
A100-34M	1/2" M

MILTON (BRASS) - AMERICAN



QUICK COUPLER

Model No.	SIZE	Model No.	SIZE
A102-12F	1/4" F	A102-12H	1/4" H
A102-13F	3/8" F	A102-13H	3/8" H
A102-14F	1/2" F	A102-14H	1/2" H
A102-12M	1/4" M	A102-15H	5/16" H
A102-13M	3/8" M	A102-16510	6.5x10MM
A102-14M	1/2" M	A102-1812	8x12MM



FEMALE PLUG
BRASS OR ZINC COATED

Model No.	SIZE
A102-22F	1/4" F
A102-23F	3/8" F
A102-24F	1/2" F



MALE PLUG
BRASS OR ZINC COATED

Model No.	SIZE
A102-32M	1/4" M
A102-33M	3/8" M
A102-34M	1/2" M

ARO TYPE (BRASS)



QUICK COUPLER

Model No.	SIZE	Model No.	SIZE
A103-12F	1/4" F	A103-12H	1/4" H
A103-13F	3/8" F	A103-13H	3/8" H
A103-14F	1/2" F	A103-14H	1/2" H
A103-12M	1/4" M	A103-15H	5/16" H
A103-13M	3/8" M		
A103-14M	1/2" M		



FEMALE PLUG

Model No.	SIZE
A103-22F	1/4" F
A103-23F	3/8" F
A103-24F	1/2" F



MALE PLUG

Model No.	SIZE
A103-32M	1/4" M
A103-33M	3/8" M
A103-34M	1/2" M



HOSE PLUG

Model No.	SIZE
A103-42H	1/4" H
A103-43H	3/8" H
A103-44H	1/2" H

TRUFLATE TYPE (BRASS)



QUICK COUPLER

Model No.	SIZE	Model No.	SIZE
A104-12M	1/4" M	A104-12H	1/4" H
A104-13M	3/8" M	A104-13H	3/8" H
A104-14M	1/2" M	A104-14H	1/2" H
A104-12F	1/4" F	A104-15H	5/16" H
A104-13F	3/8" F		
A104-14F	1/2" F		



FEMALE PLUG

Model No.	SIZE
A104-22F	1/4" F
A104-23F	3/8" F
A104-24F	1/2" F



MALE PLUG

Model No.	SIZE
A104-32M	1/4" M
A104-33M	3/8" M
A104-34M	1/2" M



HOSE PLUG

Model No.	SIZE
A104-42H	1/4" H
A104-43H	3/8" H
A104-44H	1/2" H
A104-45H	5/16" H

JAMEC TYPE (BRASS) - AUSTRALIA



QUICK COUPLER

Model No.	SIZE	Model No.	SIZE
A105-12F	1/4" F	A105-12H	1/4" H
A105-13F	3/8" F	A105-13H	3/8" H
A105-14F	1/2" F	A105-14H	1/2" H
A105-12M	1/4" M	A105-15H	5/16" H
A105-13M	3/8" M		
A105-14M	1/2" M		



FEMALE PLUG

Model No.	SIZE
A105-22F	1/4" F
A105-23F	3/8" F
A105-24F	1/2" F



MALE PLUG

Model No.	SIZE
A105-32M	1/4" M
A105-33M	3/8" M
A105-34M	1/2" M



HOSE PLUG

Model No.	SIZE
A105-42H	1/4" H
A105-43H	3/8" H
A105-44H	1/2" H
A105-45H	5/16" H

ORION TYPE (BRASS) - EUROPE



COUPLER AND PLUG (BRASS ZINC PLATE)

Model No.	SIZE	Model No.	SIZE
A106-12F	1/4" F	A106-12H	1/4" H
A106-13F	3/8" F	A106-13H	3/8" H
A106-14F	1/2" F	A106-14H	1/2" H
A106-12M	1/4" M	A106-15H	5/16" H
A106-13M	3/8" M		
A106-14M	1/2" M		



FEMALE PLUG

Model No.	SIZE
A106-22F	1/4" F
A106-23F	3/8" F
A106-24F	1/2" F



MALE PLUG

Model No.	SIZE
A106-32M	1/4" M
A106-33M	3/8" M
A106-34M	1/2" M



HOSE PLUG
(BRASS ZINC PLATE)

Model No.	SIZE
A106-42H	1/4" H
A106-43H	3/8" H
A106-44H	1/2" H
A106-45H	5/16" H



MALE PLUG SIZE

Model No.	M11*1.0
A106-5111	

QUICK COUPLER - STEEL

MATERIAL	STEEL
WORKING PRESSURE	15 KGF/CM ²
MAXIMUM PRESSURE	20 KGF/CM ²
TEMP. RANGE	-20°C to 80°C
SIZE	1/4" 1/2" 3/8"



Model No.	SIZE
SH20A	5/16" (HOSE)
SH30A	3/8" (HOSE)
SH40A	1/2" (HOSE)



Model No.	SIZE
SF20A	1/4" (PT)
SF30A	3/8" (PT)
SF40A	1/2" (PT)



Model No.	SIZE
SM20A	1/4" (PT)
SM30A	3/8" (PT)
SM40A	1/2" (PT)



Model No.	SIZE
SP20A	5 X 8 MM
SP30A	6.5 X 10MM
SP40A	8 X 12MM



Model No.	SIZE
PH20A	5/16" HOSE
PH30A	3/8" HOSE
PH40A	1/2" HOSE



Model No.	SIZE
PF20A	1/4" PT
PF30A	3/8" PT
PF40A	1/2" PT



Model No.	SIZE
PM20A	1/4" PT
PM30A	3/8" PT
PM40A	1/2" PT



Model No.	SIZE
PP20A	5 X 8 MM
PP30A	6.5 X 10MM
PP40A	8 X 12MM

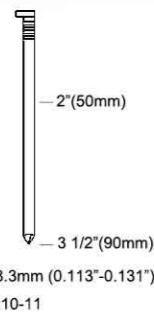

9021
Air finishing nailer - 21°

- Feature: Bumper fire
- Applications: Sawtooth safety that digs in for precision toe-nailing, Adjustable exhaust, Soft grip handle to reduce fatigue, Adjustable depth of drive, no mar bumper, Magnesium housing to keep tool light

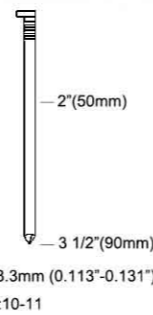

9034
Air finishing nailer - 34°

- Feature: Bumper fire
- Applications: Sawtooth safety that digs in for precision toe-nailing, Adjustable exhaust, Soft grip handle to reduce fatigue, Adjustable depth of drive, no mar bumper, Magnesium housing to keep tool light



CN-90
Coil nailer

- Applications: Making pallets, drums and wooden boxes; Siding, decking and sheathing



CN-55
Coil nailer

- Applications: Making pallets, drums and wooden boxes; Siding, decking and sheathing



F1850
Air nailer -50mm length

- Feature: Adjustable exhaust
- Applications: Soft grip handle reduce fatigue, Touch-strike security system is safe for the operator



F1832
Air nailer -32mm length

- Feature: Adjustable exhaust
- Applications: Touch-strike security system is safe for the operator

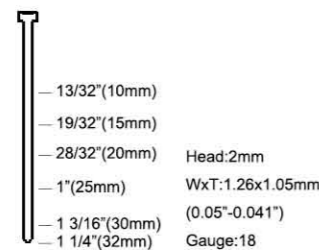

F1830
Air nailer -30mm length

- Feature: Adjustable exhaust
- Applications: Soft grip handle reduces fatigue, Touch-strike security system is safe for the operator



CN-57
Coil nailer

- Applications: Making pallets, drums and wooden boxes; Siding, decking and sheathing



CN-70
Coil nailer

- Applications: Making pallets, drums and wooden boxes; Siding, decking and sheathing



CN-80
Coil nailer

- Applications: Making pallets, drums and wooden boxes; Siding, decking and sheathing

15° WIRE COIL NAILS

Wire Shank Length	
2.1mm (0.083")	25~50mm (1"~2")
2.3mm (0.090")	25~57mm (1"~2-1/4")
2.5mm (0.099")	45~64mm (1-3/4"~2-1/2")
2.87mm (0.113")	50~75mm (2"~3")
3.05mm (0.120")	50~90mm (2"~3-1/2")
3.33mm (0.131")	50~95mm (2"~3-3/4")

Model No.	Material of Body	Air consumption	Loading capacity	Required Pressure	Max pressure	Fastner	"Dimension WidthxHighxLength (cm)"
9021	MAGNESIUM	10CFM	60pcs	70-100PSI	120PSI	10-11G/90MM/21°	53 X 37 X 11
9034	MAGNESIUM	10CFM	80pcs	70-100PSI	120PSI	10-11G/90MM/34°	41 X 38 X 11
F1850	ALUMINIUM	2.36CFM	120pcs	60-100PSI	120PSI	18G/50MM	25 X 23 X 5.5
F1832	ALUMINIUM	1.94CFM	110pcs	60-100PSI	120PSI	18G/32MM	24 X 19 X 5.5
F1830	ALUMINIUM	1.94CFM	100pcs	60-100PSI	120PSI	18G/30MM	24 X 18.5 X 5.5

Model No.	Material of Body	Weight		Magazine Capacity	Nail head diameter		Nail shank diameter		Nail length		Nail spacing	Operating pressure	PACKAGE1 blow moldcase	PACKAGE2 hard paper box
		kgs.	lbs		mm	in.	mm	in.	mm	in.				
CN-90	Aluminum body	4.10	9.02	225-275nails	6-8	0.236-0.315	2.87-3.33	0.113-0.131	50-90	2-3 9/16	8mm	5-8.5	70-100	APC/CTN 710*415*420mm 25/216KG APC/CTN 590*330*420mm 20/21KG
CN-55	Aluminum body	2.88	6.33	250-400 nails	-	-	2.1-2.5	0.083-0.098	32-57	1 1/4-2 1/8	6.8&8.8mm	5-7	70-100	APC/CTN 710*415*420mm 19/20KG APC/CTN 590*330*420mm 16/17KG
CN-57	Aluminum/Magnesium	2.50/2.35	5.50/5.17	300-350 nails	-	-	2.1-2.3	0.082-0.091	25-57	1-2 1/8	6.8mm	5-7	70-100	APC/CTN 710*415*420mm 18/19.5KG APC/CTN 590*330*420mm 13/14.5KG
CN-70	Aluminum/Magnesium	3.67/3.38	8.07/7.44	225-300 nails	5-7	0.197-0.276	2.3-2.9	0.092-0.113	45-70	1 3/4-2 3/4	-	5-7	70-100	APC/CTN 710*415*420mm 22/23KG APC/CTN 590*330*420mm 17/18KG
CN-80	Aluminum/Magnesium	3.99/3.68	8.78/8.09	225-300 nails	6-8	0.236-0.315	2.5-3.3	0.098-0.130	50-83	2-3 1/4	-	5-7	70-100	APC/CTN 710*415*420mm 24/25KG APC/CTN 590*330*420mm 19/20KG

AT-5049BK
16Pcs 1/2"DR. Impact Wrench Kit

- 1PC AT-5049B
- 10PCS AIR SOCKETS 9,10,11,13,14,17,19,22,24,27MM
- 1PC 5" EXTENSION BAR
- 1PC OIL POT
- 1PC NIPPLE
- 1PC MINI OILER
- 1PC BLOW CASE

AT-5000H
16Pcs 1/2"DR. Impact & Ratchet Wrench Kit

- 1PC AT-5040
- 1PC AT-5053H
- 10PCS AIR SOCKETS 9,10,11,13,14,17,19,22,24,27MM
- 1PC OIL POT
- 1PC NIPPLE
- 1PC MINI OILER
- 1PC BLOW CASE

AT-7330PK
3" Composite Polisher Kit

- 3" BACKING PAD
- 3.5" FOAM COMPOUNDING PADS (WHITE, YELLOW)
- 3.5" WOOL BUFFING PAD
- SPANNER WRENCH

AT-7230SK
2" & 3" Composite Surface Preparation Tool Kit

- DISC SANDER
- 3" BACKING PAD 2" BACKING PAD
- 3" FINE, MEDIUM AND COARSE
- SURFACE (BROWN#80, RED#150, BLUE#300)
- 2" FINE, MEDIUM AND COARSE
- SURFACE (BROWN#80, RED#150, BLUE#300)
- 3" SANDING DISC#80, #100, #120
- 2" SANDING DISC#80, #100, #120
- SPANNER WRENCH
- FREE SPEED: 16,000 RPM
- MAX: 2" OR 3"
- AIR CONSUMPTION: 3.5 CFM
- SPINDLE SIZE: 1/4"-20T

AT-5001H
16Pcs 3/8"DR. Impact & Ratchet Wrench Kit

- 1PC AT-5052H
- 7PCS AIR SOCKETS 10,11,12,13,14,17,19MM
- 3PCS BITS
- 1PC OIL POT
- 1PC NIPPLE
- 1PC U-JOINT
- 1PC 1/4" x 3"L EXTENSION BAR
- 1PC BLOW CASE

AT-R280CK
Rust & Paint Removal Tool Kit

- 1PC AT-R280C (CENTRAL VACUUM)
- 1PC RUBBER ERASER WHEEL
- 1PC STRIPPING WHEEL
- 1PC HUB
- 3PCS WIRE WHEEL
- 1PC NIPPLE
- 1PC HEX WRENCH
- 1PC SCREW
- 1PC BLOW CASE

AT-7330HK
3" Composite Orbital Sander Kit

- 2" SANDING PAPER #320X10, #400X10, #600X10G
- 3" SAND PAPER #320X10, #400X10, #600X10G
- 3" AIR COMPOSITE ORBITAL
- SANDER KIT
- 2" BACKING PAD
- 3" BACKING PAD
- SPANNER WRENCH

AT-7330SK
3" Composite Surface Preparation Tool Kit

- 3" BAKING PAD
- 3" FINE, MEDIUM AND COARSE
- SURFACE PREP DISC
- 3" SANDING DISC: #80X10, #100X10, #120X10G
- FREE SPEED: 16000 RPM
- AIR CONSUMPTION: 3.5 CFM
- OVERALL LENGTH: 145MM

AT-7033D(M)K
1/4" (6mm) Die Grinder Kit

- 1 PC AT-7033D(M) DIE GRINDER
- 2 PCS SPANNERS
- 5 PCS 1/4" SHANK GRINDING STONES
- 5 PCS 1/8" SHANK GRINDING STONES
- 1 PC 1/8" COLLECT
- 1 PC NIPPLE
- 1 PC BLOW CASE
- NET WEIGHT: 1.2KGS

AT-7033(M)K
1/4" (6mm) Die Grinder Kit

- 1 PC AT-7033(M) DIE GRINDER
- 2 PCS SPANNERS
- 5 PCS 1/4" SHANK GRINDING STONES
- 5 PCS 1/8" SHANK GRINDING STONES
- 1 PC 1/8" COLLECT
- 1 PC NIPPLE
- 1 PC BLOW CASE
- NET WEIGHT: 1.2KGS

AT-R7033L(M)K
1/4" (6mm) Die Grinder Kit

- 1 PC AT-R7033L(M) DIE GRINDER
- 2 PCS SPANNERS
- 5 PCS 1/4" SHANK GRINDING STONES
- 5 PCS 1/8" SHANK GRINDING STONES
- 1 PC 1/8" COLLECT
- 1 PC NIPPLE
- 1 PC BLOW CASE
- NET WEIGHT: 1.0KGS

AT-7034D(M)K
1/4" (6mm) Angle Die Grinder Kit

- 1 PC AT-7034D(M) ANGLE DIE GRINDER
- 2 PCS SPANNERS
- 5 PCS 1/4" SHANK GRINDING STONES
- 5 PCS 1/8" SHANK GRINDING STONES
- 1 PC 1/8" COLLECT
- 1 PC NIPPLE
- 1 PC BLOW CASE
- NET WEIGHT: 1.3KGS

AT-7034(M)K
1/4" (6mm) Angle Die Grinder Kit

- 1 PC AT-7034(M) ANGLE DIE GRINDER
- 2 PCS SPANNERS
- 5 PCS 1/4" SHANK GRINDING STONES
- 5 PCS 1/8" SHANK GRINDING STONES
- 1 PC 1/8" COLLECT
- 1 PC NIPPLE
- 1 PC BLOW CASE
- NET WEIGHT: 1.0KGS

AT-R7136L(M)K
1/4" (6mm) Angle Die Grinder Kit

- 1 PC AT-R7136L(M) DIE GRINDER
- 1 PC 2" ROLOC PAD
- 2 PCS SPANNERS
- 5 PCS 2" ROLOC SCOTCH DISCS
- 5 PCS 1/4" SHANK GRINDING STONES
- 5 PCS 1/8" SHANK GRINDING STONES
- 1 PC 1/8" COLLECT
- 1 PC NIPPLE
- 1 PC BLOW CASE
- NET WEIGHT: 1.8KGS

SPIN PULL KIT
AT-6200
Air Hydraulic Spin Pull Tool Composite Body

- FREE SPEED: 1200 RPM
- TRACTION POWER: 2100 KG/ 4620LBS
- SETTING CAPACITY: M4, M5, M6, M8, M10, M12
- STROKE: 7MM
- WEIGHT: 2.4KG/ 5.3 LBS
- LENGTH: 260MM
- HEIGHT: 300MM
- 14/Ctn/20 KGS/3.5'

RATCHET WRENCH KIT
AT-1016K
1/2" Ratchet Wrench

- THRU-HOLE RATCHET WRENCH KIT
- 1 PC RATCHET WRENCH. AT-1016
- 14 PC THRU-HOLE SOCKET: 8,10,12,13,14,15,16,18,19,21(mm) & BITS HOLDER & ADAPTOR 1/4", 3/8", 1/2"
- 1 PC NIPPLE
- 1 PC MINI OIL
- 10 PC BITS
- 1 PC SUSPENSION RING
- 1 PC BLOW CASE



* this type of kit only offer MM of socket, if change to INCH socket need to modify tooling, MOQ: 500 sets

AT-317HDK Spot Drill Kit

- 1 PC AIR SPOT DRILL W/ 2" HOOK
- 2 PCS 6.5MM DRILL BITS
- 2 PCS 8.0MM DRILL BITS
- 1 PC SWIVEL CONNECTOR
- 1 PC MINI OILER
- 1 PC BLOW CASE



AT-6111K Body Saw Kit

- 5 PCS 32T SAW BLADES
- 5 PCS 24T SAW BLADES
- 2 PCS HEX. WRENCH (3MM & 4MM)
- 1 PC MINI OILER
- 1 PC SWIVEL CONNECTOR
- 5 PCS FILES
- 1 PC BLOW CASE



AT-6014AK Knife Kit

- 1 PC Hatted Wrench Key (5MM)
- 1 PC K01A-57MM BLADE
- 1 PC K03A-30MM BLADE
- 1 PC K05A-35MM BLADE
- 1 PC BLOW CASE



AT-2508K Needle Scaler & Flux Chipper Kit

- 1 PC BLOW CASE
- 1 PC AT-2508
- 1 PC MOIL POINT CHISEL
- 1 PC 20MM FLAT CHISEL
- 1 PC 35MM BENT CHISEL
- 1 SET NEEDLE
- 1 PC 1/4" AIR NIPPLE
- NET WEIGHT: 4 KG



HAMMER KIT

AT-2711/RK&HK 175mm Hammer Kit

- 175MM HAMMER (3,000BPM)
- W/5 CHISELS & MINI OILER
- CHISEL, 175MM



AT-2012/RK&HK 190mm Hammer Kit

- 190MM HAMMER (3,000BPM)
- W/7" CHISELS & ADAPTOR & MINI OILER & SPRING
- CHISEL, 175MM



AT-2013W/RK&HK 250mm Hammer Kit

- 250MM HAMMER (2,000BPM)
- 5PCS 175MM CHISELS & ADAPTOR & MINI OILER & SPRING
- CHISEL, 175MM



AT-317HDJK Spot Drill Kit

- 1 PC AIR SPOT DRILL W/ 2" & 5.5" HOOK
- 2 PCS 6.5MM DRILL BITS
- 2 PCS 8.0MM DRILL BITS
- 1 PC SWIVEL CONNECTOR
- 1 PC MINI OILER
- 1 PC BLOW CASE



AT-6011K Body Saw Kit

- 5 PCS 32T SAW BLADES
- 5 PCS 24T SAW BLADES
- 2 PCS HEX. WRENCH (2MM & 4MM)
- 1 PC MINI OILER
- 1 PC SWIVEL CONNECTOR
- 1 PC BLOW CASE



AT-6014K Knife Kit

- 1 PC Hatted Wrench Key (5MM)
- 1 PC K01A-57MM BLADE
- 1 PC K03A-30MM BLADE
- 1 PC K05A-35MM BLADE
- 1 PC BLOW CASE



AT-2230K Long Reach Scraper Kit

- ALUM. MATERIAL HANDLE & TUBE
- NET WEIGHT: 6.2 KGS

AT-2074 Long Reach Scraper Kit

- IRON MATERIAL HANDLE & TUBE
- NET WEIGHT: 11.5 KGS
- 1 PC BLOW CASE
- 1 PC LONG REACH SCRAPER
- 4 PCS FLAT CHISEL
- 2 PCS GRIP TUBE 500MM
- 1 PC GRIP TUBE 300MM
- 1 PC RUBBER HANDLE GRIP
- 1 PC HEX WRENCH 6MM
- 1 PC HEX WRENCH 2.5MM
- 1 PC 1/4" AIR NIPPLE



AT-2275K/R&K/H 190mm Hammer Kit

- 190MM HAMMER (3,000BPM)
- W/5 CHISELS & MINI OILER
- Ø12MM CHISEL, 175MM



AT-2064/RK&HK 190mm Hammer Kit

- 190MM HAMMER (3,600BPM)
- 5PCS 175MM CHISELS & ADAPTOR & MINI OILER & SPRING
- CHISEL, 175MM



IMPACT DRILL	CL-1438D
14.4V CORDLESS DRILL DRIVER	
Voltage	DC 14.4V
Chuck Capacity	3/8"(10mm)
No-load Speed	Low:0~400rpm Hi:0~1,400rpm
Impact Per Minute	Low:0~5000rpm Hi:0~19,000rpm
Gear train	2-speed
Clutch settings	19
Max. Torque	250in-lbs(288kg-cm)
Weight	4.5lbs(2.05kgs)
Length	8.7"(222mm)
Charge Time	1hr
14.4V 3.0Ah Li-ion battery	
Sliding Battery Pack	



IMPACT WRENCH	CL-1438W
14.4V CORDLESS IMPACT WRENCH	
Voltage	DC 14.4V
Square Driver	3/8"(9.5mm)
No-load Speed	0~2,300rpm
Impact Per Minute	0~3,000bpm
Max. Torque	160ft-lb(217N-m)
Weight	4.3lbs(1.95kgs)
Length	6.8"(173mm)
Charge Time	1hr
14.4V 3.0 Ah Li-ion battery	
Sliding Battery Pack	



IMPACT DRILL	CL-1912D
19.2V CORDLESS DRILL DRIVER	
Voltage	DC 19.2V
Chuck Capacity	1/2"(13mm)
No-load Speed	Low:0~400rpm Hi:0~1,400rpm
Impact Rate	Low:0~5,000rpm Hi:0~19,000rpm
Gear train	2-speed
Clutch settings	19
Max. Torque	300in-lbs(346kg-cm)
Weight	5.3lbs(2.4kgs)
Length	9.5"(242mm)
Charge Time	1hr
19.2V 3.0Ah Li-ion battery	
Sliding Battery Pack	



IMPACT WRENCH	CL-1912W
19.2V CORDLESS IMPACT WRENCH	
Voltage	DC 19.2V
Square Driver	1/2"(12.7mm)
No-load Speed	0~1,800rpm
Impact Per Minute	0~2,300bpm
Max. Torque	350ft-lb(474N-m)
Weight	6.6lbs(3kgs)
Length	9.3"(236mm)
Charge Time	1hr
19.2V 3.0Ah Li-ion battery	
Sliding Battery Pack	



IMPACT DRIVER	CL-1414S
14.4V CORDLESS IMPACT DRIVER	
Voltage	DC 14.4V
Square Driver	1/4"(6.35mm)
No-load Speed	0~2,300rpm
Impact Per Minute	0~3,000bpm
Max. Torque	100ft-lb(136N-m)
Weight	4.3lbs(1.95kgs)
Length	6.9"(176mm)
Charge Time	1hr
14.4V 3.0Ah Li-ion battery	
Sliding Battery Pack	



CORDLESS RIVETER	CL-1440RV
14.4V CORDLESS RIVETER SET	
Battery Type LI-ION 3.0 Ah	
Rivets capacity : 2.4mm-4.8mm (all material)	
Pulling mechanism : ball screw	
Pulling force 1870 lbs	
Stroke length 0.79" (20mm)	
Pulling time per unit : 1 sec	
Weight with battery pack 4.8 lbs (2.2kgs)	
Rivets number per battery charge : 450 pcs	
Mandrel number in collector : 100pcs	
1PC. x 14.4V Cordless Riveter	
1PC. x 14.4V 3.0Ah Li-Ion Battery (Installed in the tool)	
1PC. x 14.4V Charger	
1PC. x Power Cord	
1PC. x 3 in 1 Spanner	
1PC. x Spanner Seat	
3PCS. x Nosepieces (#2.4 #3.2 #4.0)	
1PC. x Blow Case	

